

ORCI

OCEAN ROAD
CANCER
INSTITUTE

Box 3592, Dar es Salaam, Tanzania
Tel. 2127597, Fax: 255-22-2118704



CONTRACTUAL AGREEMENT

CONTRACT NO. PA-010/2021-2022/G/37

BETWEEN

OCEAN ROAD CANCER INSTITUTE, TANZANIA

AND

KAS MEDICS LIMITED, TANZANIA

FOR

SUPPLY, INSTALLATION AND COMMISSIONING OF DIGITAL
X RAY FOR MTWARA ZONAL HOSPITAL AND MOROGORO
RHH.

Executive Director,
Ocean Road Cancer Institute
Junction Barack Obama/Luthuli roads,
P.O. Box 3592
Dar es Salaam, Tanzania

DECEMBER 2021

Form of Contract

THIS CONTRACT is made the FRIDAY 24 day of December, 2021; between OCEAN ROAD CANCER INSTITUTE (ORCI); a corporation incorporated under the laws of the United Republic of Tanzania and having its principal place of business at junction of Barack Obama road/Luthuli road P.O Box 3592 Dar es Salaam, Tanzania (hereinafter called "the Employer"), and KAS MEDICS LIMITED, a corporation incorporated under the laws of the United Republic of Tanzania and having its place of P. O Box 7856, Umoja Complex, Plot No.11, Vingunguti Industrial area, Dar es Salaam, (hereinafter called "the supplier").

WHEREAS the Employer desires to engage the Supplier for the SUPPLY, INSTALLATION AND COMMISSIONING OF DIGITAL X RAY FOR MTWARA ZONAL HOSPITAL AND MOROGORO RHH and the Supplier has agreed to such engagement upon and subject to the terms and conditions hereinafter appearing.

NOW IT IS HEREBY AGREED as follows:

**Article 1.
Contract
Documents**

- 1.1 Contract Documents (Reference GCC Clause 2)
The following documents shall constitute the Contract between the Employer and the Supplier, and each shall be read and construed as an integral part of the Contract:

This Contract Agreement and the Appendixes hereto

- a) This form of Agreement and the Appendixes hereto
- b) Letter of Acceptance
- c) Special Conditions of Contract
- d) General Conditions of Contract
- e) Supplier's Tender
- f) Bill of quantities and Price Schedules
- g) Technical Specifications and Drawings
- h) Procedures (as listed)
- i) Any other documents shall be added here
- j) Procedures (as listed)
 - New negotiation bid price

1.2 Order of Precedence (Reference GCC Clause 2)

In the event of any ambiguity or conflict between the Contract Documents listed above, the order of precedence

shall be the order in which the Contract Documents are listed in Article 1.1 (Contract Documents) above.

**Article 2.
Contract Price
and Terms of
Payment**

1.3 Definitions (Reference GCC Clause 1)
Capitalized words and phrases used herein shall have the same meanings as are ascribed to them in the General Conditions of Contract.

2.1 Contract Price (Reference GCC Clause 12)
The Employer hereby agrees to pay to the Supplier the Contract Price in consideration of the performance by the Supplier of its obligations hereunder. The Contract Price shall be the aggregate of as specified in Price Schedule TZS 1,282,000,000 (Tanzania Shillings One Billion Two Hundred Eight Two Million Only (VAT inclusive).

Breakdown

- TZS. 870,000,000 for Supply, installation and commissioning of digital x ray for Mtwara zonal Hospital and Morogoro RHH
- TZS. 148,000,000 for Supply of Advanced Ultrasound Machine for Mtwara zonal Hospital.
- TZS. 264,000,000 for Mobile Digital x-ray Mtwara zonal Hospital

or such other sums as may be determined in accordance with the terms and conditions of the Contract.

2.2 Terms of Payment (Reference GCC Clause 13)
The terms and procedures of payment according to which the Employer will reimburse the Supplier are given in the corresponding Appendix (Terms and Procedures of Payment) hereto.

The Employer (Ocean Road Cancer Institute) each shall instruct its bank to issue an irrevocable confirmed documentary credit made available to the Supplier in a bank in the country of the Supplier.

In the event that the amount payable under Schedule No. 1 is adjusted in accordance with GCC 12.2 or with any of the other terms of the Contract, the Employer shall

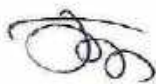

arrange for the documentary credit to be amended accordingly.

The price given above are firm and final till the completion of the contract this supply, delivery (DDP), installation, testing and commissioning of Digital x ray machine, Advanced Ultrasound Machine and Advanced Ultrasound Machine 100% payable against irrevocable, confirmed L/C payable as follows: -

- i) 65% Advance payment against acceptable Advance Payment Guarantee (bank Guarantee or insurance bond) (TZS 1,282,000,000).
- ii) 30% on completion of installation, testing and commissioning of Digital x ray machine, Advanced Ultrasound Machine and Advanced Ultrasound Machine machines and issuance of completion certificate and operational acceptance certificate issued by TANZANIA ATOMIC ENERGY COMMISSION (TAEC) but no later than 90 days from shipment date without any further presentation of documents.
- iii) 5% will be paid at clinical operational start and completion of all training (training certificates) during warranty period but no later than 90 days from shipment date without any further presentation of documents.
- iv) The projected amounts for the warrant period have been included in the gross cost payable in periodical installments. There will be no separate contract which will include successive year's warranty.

**Article 3.
Appendixes**

- 3.1 The Appendixes listed in the attached List of Appendixes shall be deemed to form an integral part of this Contract Agreement.
- 3.2 Reference in the Contract to any Appendix shall mean the Appendixes attached hereto, and the Contract shall be read and construed accordingly.



IN WITNESS WHEREOF the Employer and the Supplier have caused this Agreement to be duly executed by their duly authorized representatives the day and year first above written.

SIGNED BY, FOR AND ON BEHALF OF THE OCEAN ROAD CANCER INSTITUTE, TANZANIA:

NAME: DR JULIUS MWAUSELAGE

DESIGNATION: EXECUTIVE DIRECTOR

SIGNATURE: 



IN PRESENCE OF:

NAME: ELIFENDO KAZIMBA

DESIGNATION: HEAD OF LEGAL SERVICES

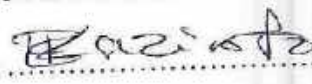
SIGNATURE: 

OFFICIAL STAMP:

SIGNED BY, FOR AND ON BEHALF OF THE KAS MEDICS LIMITED:

NAME: PADAM DAS

DESIGNATION: DIRECTOR

SIGNATURE: 



IN PRESENCE OF:

NAME: Martin Godfrey Sangira

DESIGNATION: Commissioner for Oaths

SIGNATURE: 



OFFICIAL STAMP:



THE UNITED REPUBLIC OF TANZANIA

Ocean Road Cancer Institute

Telephone: +255 22 220002

Fax:

E-mail: info@orci.or.tz



Barrack Obama Road, Lithuli
Road
Dar es Salaam
Ilala
3592, Dar es Salaam
Tanzania, United Republic Of

Date 08/12/2021

In reply please quote

PA-010/2021-22/G/37

Name of awarded PE

OCEAN ROAD CANCER INSTITUTE

RE: Supply of digital x ray machine for Mtwara zonal and Morogoro RHH. SUB: NOTIFICATION OF CONTRACT AWARD

1. Reference is being made to the bid documents submitted by 05/12/2021 , for the above captioned matter.
2. Kindly be informed that the Ocean Road Cancer Institute Tender Board during its ordinary Meeting held on 06/12/2021 , approved award of the contract to KAS MEDICS LIMITED For Supply of digital x ray machine for Mtwara zonal and Morogoro RHH. at the contract price of TZS 1282000000.00 VAT inclusive.
We hope you will provide us with best services .(Supply of digital x ray machine for Mtwara zonal and Morogoro RHH, Supply for Advanced Ultrasound Machine for Mtwara zonal and Supply of Advanced Ultrasound Machine for Mtwara zonal)

EXECUTIVE DIRECTOR

A handwritten signature in black ink.

SECTION C: SPECIAL CONDITIONS OF CONTRACT

A small, dark, handwritten scribble or signature located in the bottom left corner of the page.

Special Conditions of Contract

The following Special Conditions of Contract (SCC) shall supplement the General Conditions of Contract (GCC). Whenever there is a conflict, the provisions herein shall prevail over those in the GCC. The corresponding clause number of the GCC is indicated in parentheses.

[Instructions for completing the SCC are provided, as needed, in the notes in italics mentioned for the relevant Special Conditions. Where sample provisions are furnished, they are only illustrative of the provisions that the Employer should draft specifically for each procurement. Several provisions and related information shall be either completed or modified in accordance with the information provided by the Tenderer whose Tender has been accepted by the Employer or agreed between that Tenderer and the Employer.]

SCC Clause Number	GCC Clause Number	Amendments of, and Supplements to, Clauses in the GCC
Definitions (GCC 1)		
1.	1.1	<p>The Employer is: Ocean Road Cancer Institute Luthuli/Samora avenue, P.O Box 3592 Tel. +255 22 2127597 Fax 255-22-2118704 Dar Es Salaam</p> <p>The Project Manager is: To be known later</p> <p>The Contractor is: KAS MEDICS LIMITED. P. O Box 7856, Umoja Complex, Plot No.11, Vingunguti Industrial area, Dar es Salaam,</p> <p>The Contractor's Representative is: DOMIC MBITHI</p> <p>The Contractor's Representative is: DR. REVELIAN IRAMU</p> <p>The Appointing Authority of the Adjudicator is: TANZANIA INSTITUTE OF ARBITRATION</p> <p>Country of Origin: all countries and territories as indicated in the section of the Tendering Documents, Eligibility for the Provision of Goods, Works and Services.</p> <p>Time for Completion:</p> <ul style="list-style-type: none"> • <i>Three month (3) from the date of contract sign, for supply of Digital X Ray.</i>



		<p>Sample Provision</p> <p>Time for Completion for all Facilities: [The time shall be specified in days, weeks or months, as appropriate, and shall be written in words and figures.], or</p> <p>Time for Completion for parts of the Facilities:</p> <p>Description Time for Completion</p> <p>Weeks:.....or month:.....or Date.....</p>
Notices (GCC Clause 4)		
2.	4.1	<p>Employer's address for notice purposes:</p> <p>Executive Director, Ocean Road Cancer Institute Luthuli/Samora avenue, P. o Box 3592 Tel. +255 22 2127597 Fax 255-22-2118704 Dar Es Salaam - through ONLINE-TANePS (Tanzanian National e-Procurement System)</p> <p>Contractor's address for notice purposes: KAS MEDICS LIMITED. P. O Box 7856, Umoja Complex, Plot No.11, Vingunguti Industrial area, Dar es Salaam,</p>
Governing Law (GCC 5)		
3.	5.1	<p>Sample Provision</p> <p>GCC 5.1 – The Contract shall be interpreted in accordance with the laws of Tanzania.</p>
Settlement of Disputes (GCC 6)		
4.	6.1.3	Adjudicator's hourly fee: To be known later
5	6.1.4	Appointing Authority for Adjudicator: Tanzania Institute Arbitration
6	6.2.3	<p>Rules of procedure for arbitration proceedings:</p> <p>(a) <u>Contracts with foreign contractors:</u></p> <p>GCC 6.2.3 (a)--All disputes arising in connection with the present Contract shall be finally settled under the Rules of Conciliation and Arbitration of the International Chamber</p>

		of Commerce by one or more arbitrators appointed in accordance with said Rules.
Scope of Facilities [Spare Parts] (GCC Clause 9)		
7.	9.3	The Contractor agrees to supply spare parts for a period of ten (10) years: -also stated in specification in brief
8.	9.3	The Contractor shall carry sufficient inventories to ensure an ex-stock supply of consumable spares for the goods. Other spare parts and components shall be supplied as promptly as possible, but at the most within six (6) months of placing the order and opening the letter of credit. In addition, in the event of termination of the production of spare parts, advance notification will be made to the Employer of the pending termination, with sufficient time to permit the Employer to procure the needed requirement. Following such termination, the Contractor will furnish to the extent possible and at no cost to the Employer the blueprints, drawings and specifications of the spare parts, if requested.
Time for Commencement and Completion (GCC 10)		
9.	10.1	The Contractor shall commence work on the Facilities from the Effective Date for determining Time for Completion as specified in the Contract Agreement.
10.	10.2	The Completion of the Facilities shall be attained within Weeks: (12) weeks or month: (3)three or Date.....
Contract Price (GCC Clause 12)		
11.	12.2	The Contract Price shall be adjusted in accordance with the provisions of the corresponding Appendix (Fixed Price) to the Contract Agreement
Securities (GCC 14)		

12.	14.3.1	The amount of performance security, as a percentage of the Contract Price for the Facility or for the part of the Facility for which a separate time for Completion is provided, shall be: (10%) Ten percent
13.	14.3.2	The performance security shall be in the form of the bank Guarantee or insurance bond attached hereto in the section on Sample Forms and Procedures.
14.	14.3.3	The performance security shall be reduced to ten percent (10%) of the value of the component covered by the extended warranty to cover the Contractor's extended warranty in accordance with the provision in the SCC, pursuant to GCC 28.10.
Work Programme (GCC 19)		
15.	19.2	The form of the programme of performance of the Contract shall be: Programme of performance shall usually be in the form of the critical path method (CPM)
Commissioning and Operational Acceptance (GCC 26)		
16.	26.2.2	The Guarantee Test of the Facilities shall be successfully completed within 90 days from the date of Completion.
Completion Time Guarantee (GCC Clause 27)		
17.	27.2	Applicable rate for liquidated damages: 0.15 percent per day. Maximum deduction for liquidated damages: is equal to the Performance Security quoted.
18.	27.3	No bonus will be given for earlier Completion of the Facilities or part thereof.
Defect Liability (GCC 28)		
19.	28.10	Defect Liability Period shall be twenty four (24) months from the date of completion of the facilities. <i>[The Employer should not extend the Defect Liability Period beyond the period prescribed in GCC 28.2, except where it is</i>

		<p><i>commercial practice for that type of Facilities, and in which case the relevant period shall be specified in the SCC under GCC 28.10.]</i></p> <p>The critical components covered under the extended warranty are -five (5) years.</p> <p>Five years comprehensive maintenance should include service, spare parts and labour starting from the day of the acceptance testing of the machine. Lifetime support: spare parts, consumables should be available throughout the lifetime period of the machine</p>
--	--	--

Completion – Guarantee Test – Acceptance (GCC 25.3 and 26.2)

20.	25.3 and 26.2	<p><i>Sample Provision</i></p> <p>21.1 In the event that the Contractor is unable to proceed with the Pre-commissioning of the Facilities pursuant to GCC 25.3, or with the Guarantee Test pursuant to GCC 26.2, for reasons attributable to the Employer either on account of non-availability of other facilities under the responsibilities of other contractor(s), or for reasons beyond the Employer's control, the provisions leading to "deemed" completion of activities such as Completion, pursuant to GCC 25.6, and Operational Acceptance, pursuant to GCC 26.3.4, and Contractor's obligations regarding Defect Liability Period, pursuant to GCC 28.2, Functional Guarantee, pursuant to GCC 29, and Care of Facilities, pursuant to GCC 33, and GCC 42.1, Suspension, shall not apply. In this case, the following provisions shall apply.</p> <p>21.2 When the Contractor is notified by the Project Manager that he will be unable to proceed with the activities and obligations pursuant to above GCC 14.1, the Contractor shall be entitled to the following:</p> <ul style="list-style-type: none"> (a) the Time of Completion shall be extended for the period of suspension without imposition of liquidated damages pursuant to GCC 27.2; (b) payments due to the Contractor in accordance with the provision specified in the corresponding Appendix (Terms and Procedures of Payment) to the Contract Agreement, which would not have
-----	---------------	---

been payable in normal circumstances due to non-completion of the subject activities, shall be released to the Contractor against submission of a security in the form of a bank guarantee of equivalent amount acceptable to the Employer, and which shall become null and void when the Contractor will have complied with its obligations regarding those payments, subject to the provision of GCC 14.3 below;

(c) the expenses towards the above security and extension of other securities under the contract, of which validity needs to be extended, shall be reimbursed to the Contractor by the Employer;

(d) the additional charges towards the care of the Facilities pursuant to GCC 33.1 shall be reimbursed to the Contractor by the Employer for the period between the notification mentioned above and the notification mentioned in GCC 14.4 below. The provision of GCC 34.2 shall apply to the Facilities during the same period.

21.3 In the event that the period of suspension under above GCC 14.1 actually exceeds one hundred eighty (180) days, the Employer and Contractor shall mutually agree to any additional compensation payable to the Contractor.

21.4 When the Contractor is notified by the Project Manager that the plant is ready for Pre-commissioning, the Contractor shall proceed without delay in performing all the specified activities and obligations under the contract.

[The above SCC 14 may be used when performance of Pre-commissioning activities and/or Functional Guarantees will be tied to the completion of other facilities which are not under the responsibilities of the Contractor (e.g., completion of transmission lines to connect to the grid a power plant constructed under the Contract).]

SECTION D: GENERAL CONDITIONS OF CONTRACT

Table of Clauses

A. Contract and Interpretation	16
1. Definitions.....	16
2. Interpretation order of Documents.....	19
3. Conditions Precedent.....	21
4. Notices.....	22
5. Language and Law.....	22
6. Disputes Resolution.....	22
7. Fees and Cost of Adjudicators.....	23
8. Replacement of an Adjudicator.....	23
B. Subject Matter of Contract	23
9. Scope of Facilities.....	23
10. Time for Commencement and Completion.....	24
11. Parties' Responsibilities.....	24
C. Payment	27
12. Contract Price.....	27
13. Terms of Payment.....	27
14. Securities.....	28
15. Taxes and Duties.....	29
D. Intellectual Property	30
16. Patent and Copyright.....	30
17. Confidential Information.....	30
E. Execution of the Facilities	31
18. Representatives.....	31
19. Work Programme.....	33
20. Subcontracting.....	35
21. Design and Engineering.....	35
22. Procurement.....	38
23. Installation.....	40
24. Test and Inspection.....	44
25. Completion of the Facilities.....	46
26. Commissioning and Operational Acceptance.....	48
F. Guarantees and Liabilities	50
27. Completion Time Guarantee.....	50
28. Defect Liability.....	51
29. Functional Guarantees.....	53
30. Patent Indemnity.....	54
31. Limitation of Liability.....	55
G. Risk Distribution	55
32. Transfer of Ownership.....	55
33. Care of Facilities.....	56
34. Loss of or Damage to Property; Accident or Injury to Workers; Indemnification.....	58
35. Insurance.....	59

36. Unforeseen Conditions	62
37. Change in Laws and Regulations	63
38. Force Majeure	63
39. War Risks	65
H. Change in Contract Elements	66
40. Change in the Facilities	66
41. Extension of Time for Completion	70
42. Suspension	71
43. Termination	72
44. Assignment	80

A. Contract and Interpretation

1	Definitions	1.1	<p>The following words and expressions shall have the meanings hereby assigned to them:</p> <p>"Contract" means the Agreement entered into between the Employer and the Contractor, together with the Contract Documents referred to therein; they shall constitute the Contract, and the term "the Contract" shall in all such documents be construed accordingly.</p> <p>"Contract Documents" means the documents listed in Article 1.1 (Contract Documents) of the Form of Agreement (including any amendments thereto).</p> <p>"GCC" means the General Conditions of Contract hereof.</p> <p>"SCC" means the Special Conditions of Contract.</p> <p>"Day" means calendar day..</p> <p>"Month" means calendar month..</p> <p>"Employer" means the person named as such in the SCC and includes the legal successors or permitted assigns of the Employer.</p> <p>"Project Manager" means the person appointed by the Employer in the manner provided in GCC 18.1 (Project Manager) hereof and named as such in the SCC to perform the duties delegated by the Employer.</p> <p>"Contractor" means the person(s) whose tender to perform the Contract has been accepted by the Employer and is named as such in the Agreement, and includes the legal successors or permitted assigns of the Contractor.</p> <p>"Contractor's Representative" means any person nominated by the Contractor and named as such in the SCC and approved by the Employer in the manner provided in GCC 18.2 (Contractor's Representative and Construction Manager) hereof to perform the duties delegated by the Contractor.</p> <p>"Subcontractor," including vendors, means any person to whom execution of any part of the Facilities,</p>
---	-------------	-----	---

including preparation of any design or supply of any Goods, is sub-contracted directly or indirectly by the Contractor, and includes its legal successors or permitted assigns.

"Adjudicator" means the person or persons appointed by the Appointing Authority named in the SCC to make a decision on or to settle any dispute or differences between the Employer and the Contractor referred to him or her by the parties pursuant to GCC 6.1 (Adjudicator) hereof.

"Contract Price" means the sum specified in Article 2.1 (Contract Price) of the Agreement, subject to such additions and adjustments thereto or deductions therefrom, as may be made pursuant to the Contract.

"Facilities" means the Goods to be supplied and installed, as well as all the Installation Services to be carried out by the Contractor under the Contract.

"Force Majeure" shall mean any event beyond the reasonable control of the Employer or of the Contractor, as the case may be, and which is unavoidable notwithstanding the reasonable care of the party affected.

"Goods" means permanent plant, equipment, machinery, apparatus, articles and things of all kinds to be provided and incorporated in the Facilities by the Contractor under the Contract (including the spare parts to be supplied by the Contractor under GCC 7.3 hereof), but does not include Contractor's Equipment.

"Installation Services" means all those services ancillary to the supply of the Goods for the Facilities, to be provided by the Contractor under the Contract; e.g., transportation and provision of marine or other similar insurance, inspection, expediting, site preparation works (including the provision and use of Contractor's Equipment and the supply of all construction materials required), installation, testing, pre-commissioning, commissioning, operations, maintenance, the provision of operations and maintenance manuals, training, etc.

"Contractor's Equipment" means all plant, facilities, equipment, machinery, tools, apparatus, appliances or things of every kind required in or for installation, completion and maintenance of Facilities that are to be provided by the Contractor, but does not include

Goods, or other things intended to form or forming part of the Facilities.

"Country of Origin" means the countries and territories eligible under the PPA 2004 and its corresponding Regulations as further elaborated in the SCC.

"Site" means the land and other places upon which the Facilities are to be installed, and such other land or places as may be specified in the Contract as forming part of the Site.

"Effective Date" means the date of fulfillment of all conditions stated in Article 3 (Effective Date for Determining Time for Completion) of the Form of Agreement, for the purpose of determining the Time for Completion.

"Time for Completion" means the time within which Completion of the Facilities as a whole (or of a part of the Facilities where a separate Time for Completion of such part has been prescribed) is to be attained in accordance with the specifications in the SCC and the relevant provisions of the Contract.

"Completion" means that the Facilities (or a specific part thereof where specific parts are specified in the SCC) have been completed operationally and structurally and put in a tight and clean condition, and that all work in respect of Pre-commissioning of the Facilities or such specific part thereof has been completed; in other words, that the Facilities or specific part thereof are ready for Commissioning as provided in GCC 25 (Completion) hereof.

"Pre-commissioning" means the testing, checking and other requirements specified in the Technical Specifications that are to be carried out by the Contractor in preparation for Commissioning as provided in GCC 25 (Completion) hereof.

"Commissioning" means operation of the Facilities or any part thereof by the Contractor following Completion, which operation is to be carried out by the Contractor as provided in GCC 26.1 (Commissioning) hereof, for the purpose of carrying out Guarantee Test(s).

"Guarantee Test(s)" means the test(s) specified in the Technical Specifications to be carried out to ascertain whether the Facilities or a specified part thereof is

		<p>able to attain the Functional Guarantees specified in the Technical Specifications in accordance with the provisions of GCC 26.2 (Guarantee Test) hereof.</p> <p>"Operational Acceptance" means the acceptance by the Employer of the Facilities (or any part of the Facilities where the Contract provides for acceptance of the Facilities in parts), which certifies the Contractor's fulfillment of the Contract in respect of Functional Guarantees of the Facilities (or the relevant part thereof) in accordance with the provisions of GCC 29 (Functional Guarantees) hereof and shall include deemed acceptance in accordance with GCC 26 (Commissioning and Operational Acceptance) hereof.</p> <p>"Defect Liability Period" means the period of validity of the warranties given by the Contractor commencing at Completion of the Facilities or a part thereof, during which the Contractor is responsible for defects with respect to the Facilities (or the relevant part thereof) as provided in GCC 28 (Defect Liability) hereof.</p>	
2	Interpretation order of Documents	2.1	In interpreting these Conditions of Contract headings and marginal notes are used for convenience only and shall not affect their interpretations unless specifically stated; references to singular include the plural and vice versa; and masculine include the feminine. Words have their ordinary meaning under the language of the Contract unless specifically defined.
		2.2	If any of the Contract Documents, correspondence or communications are prepared in any language other than the governing language under GCC 2.1 above, the English translation of such documents, correspondence or communications shall prevail in matters of interpretation.
		2.3	<p>The documents forming the Contract shall be interpreted in the following order of priority:</p> <ol style="list-style-type: none"> (1) Form of Agreement, (2) Special Conditions of Contract, (3) Conditions of Contract, (4) Letter of Acceptance, (5) Certificate of Contract Commencement (6) Specifications, (7) Drawings,

		<p>(8) Bill of Quantities,</p> <p>(9) Contractor's Tender, and</p> <p>Any other document listed in the Special Conditions of Contract as forming part of the Contract.</p>
	2.4	<p><u>Persons</u></p> <p>Words importing persons or parties shall include firms, corporations and government entities.</p>
	2.5	<p><u>Incoterms</u></p> <p>Unless inconsistent with any provision of the Contract, the meaning of any trade term and the rights and obligations of parties there under shall be as prescribed by <i>Incoterms</i>.</p> <p><i>Incoterms</i> means international rules for interpreting trade terms published by the International Chamber of Commerce (latest edition), 38 Cours Albert 1^{er}, 75008 Paris, France.</p>
	2.6	<p><u>Entire Agreement</u></p> <p>Subject to GCC 17.4 hereof, the Contract constitutes the entire agreement between the Employer and Contractor with respect to the subject matter of Contract and supersedes all communications, negotiations and agreements (whether written or oral) of parties with respect thereto made prior to the date of Contract.</p>
	2.7	<p><u>Amendment</u></p> <p>No amendment or other variation of the Contract shall be effective unless it is in writing, is dated, expressly refers to the Contract, and is signed by a duly authorized representative of each party hereto.</p>
	2.8	<p><u>Independent Contractor</u></p> <p>The Contractor shall be an independent contractor performing the Contract. The Contract does not create any agency, partnership, joint venture or other joint relationship between the parties hereto.</p> <p>Subject to the provisions of the Contract, the Contractor shall be solely responsible for the manner in which the Contract is performed. All employees, representatives or Subcontractors engaged by the Contractor in connection with the performance of the Contract shall be under the complete control of the Contractor and shall not be deemed to be employees of the Employer, and nothing contained in the Contract or in any subcontract awarded by the Contractor shall be construed to create any contractual relationship between any such employees, representatives or Subcontractors and the Employer.</p>

Jos

		2.9	<u>Joint Venture or Consortium</u> If the Contractor is a joint venture or consortium of two or more persons, all such firms shall be jointly and severally bound to the Employer for the fulfillment of the provisions of the Contract and shall designate one of such persons to act as a leader with authority to bind the joint venture or consortium. The composition or the constitution of the joint venture or consortium shall not be altered without the prior consent of the Employer.
		2.10	<u>Non-Waiver</u> 2.10.1 Subject to GCC 2.10.2 below, no relaxation, forbearance, delay or indulgence by either party in enforcing any of the terms and conditions of the Contract or the granting of time by either party to the other shall prejudice, affect or restrict the rights of that party under the Contract, nor shall any waiver by either party of any breach of Contract operate as waiver of any subsequent or continuing breach of Contract. 2.10.2 Any waiver of a party's rights, powers or remedies under the Contract must be in writing, must be dated and signed by an authorized representative of the party granting such waiver, and must specify the right and the extent to which it is being waived.
		2.11	<u>Severability</u> If any provision or condition of the Contract is prohibited or rendered invalid or unenforceable, such prohibition, invalidity or unenforceability shall not affect the validity or enforceability of any other provisions and conditions of the Contract.
		2.12	<u>Country of Origin</u> "Origin" means the place where the materials, equipment and other supplies for the Facilities are mined, grown, produced or manufactured, and from which the services are provided.
3	Conditions Precedent	3.1	Having signed the Contract, it shall come into effect on the date on which the following conditions have been satisfied: - a) Submission of performance Security in the form specified in the SCC; b) Furnishing of Advance Payment Unconditional Guarantee.

		3.2	If the Condition precedent stipulated on GCC 3.1 is not met by the date specified in the SCC this contract shall not come into effect;
		3.3	If the Employer is satisfied that each of the conditions precedent in this contract has been satisfied (except to the extent waived by him, but subject to such conditions as he shall impose in respect of such waiver) he shall promptly issue to the contractor a certificate of Contract commencement, which shall confirm the start date.
4	Notices	4.1	<p>Unless otherwise stated in the Contract, all notices to be given under the Contract shall be in writing, and shall be sent by personal delivery, airmail post, special courier, cable, telegraph, telex, facsimile or Electronic Data Interchange (EDI) to the address of the relevant party set out in the SCC, with the following provisions:</p> <p>4.1.1 Any notice sent by cable, telegraph, telex, facsimile or EDI shall be confirmed within two (2) days after dispatch by notice sent by airmail post or special courier, except as otherwise specified in the Contract.</p> <p>4.1.2 Any notice sent by airmail post or special courier shall be deemed (in the absence of evidence of earlier receipt) to have been delivered ten (10) days after dispatch. In proving the fact of dispatch, it shall be sufficient to show that the envelope containing such notice was properly addressed, stamped and conveyed to the postal authorities or courier service for transmission by airmail or special courier.</p> <p>4.1.3 Any notice delivered personally or sent by cable, telegraph, telex, facsimile or EDI shall be deemed to have been delivered on date of its dispatch.</p> <p>4.1.4 Either party may change its postal, cable, telex, facsimile or EDI address or addressee for receipt of such notices by ten (10) days' notice to the other party in writing.</p>
		4.2	Notices shall be deemed to include any approvals, consents, instructions, orders and certificates to be given under the Contract.
5	Language and Law	5.1	The language of the Contract and the law governing the Contract are stated in the SCC.
6	Disputes Resolution	6.1	In the event of any dispute arising out of this contract, either party shall issue a notice of dispute to settle the dispute amicably. The parties hereto shall, within twenty eight (28) days from the notice date, use their best efforts to settle the

			dispute amicably through mutual consultations and negotiation. Any unsolved dispute may be referred by either party to an adjudicator nominated by the appointing Authority specified in SCC.
		6.2	After the dispute has been referred to the adjudicator, within 30 days, or within such other period as may be proposed by the Parties, the Adjudicator shall give its decision. The rendered decision shall be binding to the Parties.
		6.3	If either Party is dissatisfied with the Adjudicator's decision may, within days specified in the SCC refer the dispute for arbitration. If either party within the period mentioned in the SCC has not referred the matter for arbitration the decision shall become final and binding to the Parties.
		6.4	The arbitration shall be conducted in accordance with the arbitration procedure published by the Institution named and in the place shown in the SCC
7	Fees and Cost of Adjudicators	7.1	The rate of the Adjudicator's fee and administrative costs of adjudication shall be borne equally by the Parties. The rates and costs shall be in accordance with the rules of the Appointing Authority. In conducting adjudication to its finality each party shall bear its incurred costs and expenses.
8	Replacement of an Adjudicator	8.1	Should the Adjudicator resign or die, or should the Employer and the Contractor agree that the Adjudicator is not functioning in accordance with the provisions of the Contract, a new Adjudicator will be appointed by the Appointing Authority
		8.2	In the event of disagreement between the Parties to the dispute under Clause 29.1 or 29.2 above, the Adjudicator shall be appointed by the Appointing Authority stated in the SCC.

B. Subject Matter of Contract

9.	Scope of Facilities	9.1	Unless otherwise expressly limited in the Technical Specifications, the Contractor's obligations cover the provision of all Goods and the performance of all Installation Services required for the design, the manufacture (including procurement, quality assurance, construction, installation, associated civil works, Pre-commissioning and delivery) of the Goods and the installation, completion and commissioning of the Facilities in accordance with the plans, procedures, specifications, drawings, codes and any other documents as specified in the Technical Specifications. Such
----	---------------------	-----	---

			specifications include, but are not limited to, the provision of supervision and engineering services; the supply of labour, materials, equipment, spare parts (as specified in GCC 7.3 below) and accessories; Contractor's Equipment; construction utilities and supplies; temporary materials, structures and facilities; transportation (including, without limitation, unloading and hauling to, from and at the Site); and storage, except for those supplies, works and services that will be provided or performed by the Employer, as set forth in the corresponding Appendix (Scope of Works and Supply by the Employer) to the Agreement.
		9.2	The Contractor shall, unless specifically excluded in the Contract, perform all such work and/or supply all such items and materials not specifically mentioned in the Contract but that can be reasonably inferred from the Contract as being required for attaining Completion of the Facilities as if such work and/or items and materials were expressly mentioned in the Contract.
		9.3	In addition to the supply of Mandatory Spare Parts included in the Contract, the Contractor agrees to supply spare parts required for the operation and maintenance of the Facilities for the period specified in the SCC. However, the identity, specifications and quantities of such spare parts and the terms and conditions relating to the supply thereof are to be agreed between the Employer and the Contractor, and the price of such spare parts shall be that given in Price Schedule No. 6, which shall be added to the Contract Price. The price of such spare parts shall include the purchase price therefore and other costs and expenses (including the Contractor's fees) relating to the supply of spare parts.
10.	Time for Commencement and Completion	10.1	The Contractor shall commence work on the Facilities within the period specified in the SCC and without prejudice to GCC 27.2 hereof, the Contractor shall thereafter proceed with the Facilities in accordance with the time schedule specified in the corresponding Appendix (Time Schedule) to the Agreement.
		10.2	The Contractor shall attain Completion of the Facilities (or of a part where a separate time for Completion of such part is specified in the Contract) within the time stated in the SCC or within such extended time to which the Contractor shall be entitled under GCC 41 hereof.
11.	Parties' Responsibilities	11.1	(a) Contractor's and Employer's Responsibilities The Contractor shall design, manufacture (including associated purchases and/or subcontracting), install and

			complete the Facilities with due care and diligence in accordance with the Contract.
		11.2	The Contractor confirms that it has entered into this Contract on the basis of a proper examination of the data relating to the Facilities (including any data as to boring tests) provided by the Employer, and on the basis of information that the Contractor could have obtained from a visual inspection of the Site (if access thereto was available) and of other data readily available to it relating to the Facilities as of the date twenty-eight (28) days prior to tender submission. The Contractor acknowledges that any failure to acquaint itself with all such data and information shall not relieve its responsibility for properly estimating the difficulty or cost of successfully performing the Facilities.
		11.3	The Contractor shall acquire in its name all permits, approvals and/or licenses from all local, state or national government authorities or public service undertakings in the United Republic of Tanzania where the Site is located that are necessary for the performance of the Contract, including, without limitation, visas for the Contractor's and Subcontractor's personnel and entry permits for all imported Contractor's Equipment. The Contractor shall acquire all other permits, approvals and/or licenses that are not the responsibility of the Employer under GCC 11.3 hereof and that are necessary for the performance of the Contract.
		11.4	The Contractor shall comply with all laws in force in the United Republic of Tanzania and local by laws where the Facilities are installed and where the Installation Services are carried out. The laws will include all local, state, national or other laws that affect the performance of the Contract and bind upon the Contractor. The Contractor shall indemnify and hold harmless the Employer from and against any and all liabilities, damages, claims, fines, penalties and expenses of whatever nature arising or resulting from the violation of such laws by the Contractor or its personnel, including the Subcontractors and their personnel, but without prejudice to GCC 11.1 hereof.
		11.5	Any Plant, Material and Services that will be incorporated in or be required for the Facilities and other supplies shall have their origin as specified under GCC 1 (Country of Origin).
		11.6	The Contractor shall permit the PE to inspect the Contractor's accounts and records relating to the performance of the Contractor and to have them audited by auditors appointed by the PE, if so required by the PE.
			(b) Employer's Responsibilities

		11.7	The Employer shall ensure the accuracy of all information and/or data to be supplied by the Employer as described in the corresponding Appendix (Scope of Works and Supply by the Employer) to the Contract, except when otherwise expressly stated in the Contract.
		11.8	The Employer shall be responsible for acquiring and providing legal and physical possession of the Site and access thereto, and for providing possession of and access to all other areas reasonably required for the proper execution of the Contract, including all requisite rights of way, as specified in the corresponding Appendix (Scope of Works and Supply by the Employer) to the Agreement. The Employer shall give full possession of and accord all rights of access thereto on or before the date(s) specified in that Appendix.
		11.9	The Employer shall acquire and pay for all permits, approvals and/or licenses from all local, state or national government authorities or public service undertakings in the United Republic of Tanzania. Such authorities or undertakings require the Employer to obtain them in the Employer's name, are necessary for the execution of the Contract (they include those required for the performance by both the Contractor and the Employer of their respective obligations under the Contract), and are specified in the corresponding Appendix (Scope of Works and Supply by the Employer) to the Agreement.
		11.10	If requested by the Contractor, the Employer shall use its best endeavors to assist the Contractor in obtaining in a timely and expeditious manner all permits, approvals and/or licenses necessary for the execution of the Contract from all local, state or national government authorities or public service undertakings that such authorities or undertakings require the Contractor or Subcontractors or the personnel of the Contractor or Subcontractors, as the case may be, to obtain.
		11.11	Unless otherwise specified in the Contract or agreed upon by the Employer and the Contractor, the Employer shall provide sufficient, properly qualified operating and maintenance personnel; shall supply and make available all raw materials, utilities, lubricants, chemicals, catalysts, other materials and facilities; and shall perform all work and services of whatsoever nature, including those required by the Contractor to properly carry out Pre-commissioning, Commissioning and Guarantee Tests, all in accordance with the provisions of the corresponding Appendix (Scope of Works and Supply by the Employer) to the Agreement at or before the time specified in the programme furnished by the Contractor under GCC 19.2

			hereof and in the manner thereupon specified or as otherwise agreed upon by the Employer and the Contractor.
		11.12	The Employer shall be responsible for the continued operation of the Facilities after Completion, in accordance with GCC 25.8, and shall be responsible for facilitating the Guarantee Test(s) for the Facilities, in accordance with GCC 26.2.
		11.13	All costs and expenses involved in the performance of the obligations under this GCC 11 shall be the responsibility of the Employer, save those to be incurred by the Contractor with respect to the performance of Guarantee Tests, in accordance with GCC 26.2.

C. Payment

12.	Contract Price	12.1	The Contract Price shall be as specified in Article 2 (Contract Price and Terms of Payment) of the Form of Agreement.
		12.2	Unless indicated otherwise in the SCC, the Contract Price shall be a firm lump sum not subject to any alteration, except in the event of a Change in the Facilities or as otherwise provided in the Contract.
		12.3	Subject to GCCs 10.2, 11.1 and 36 hereof, the Contractor shall be deemed to have satisfied itself as to the correctness and sufficiency of the Contract Price, which shall, except as otherwise provided for in the Contract, cover all its obligations under the Contract.
13.	Terms of Payment	13.1	The Contract Price shall be paid as specified in the corresponding Appendix (Terms and Procedures of Payment) to the Agreement. The procedures to be followed in making application for and processing payments shall be those outlined in the same Appendix.
		13.2	No payment made by the Employer herein shall be deemed to constitute acceptance by the Employer of the Facilities or any part(s) thereof.
		13.3	In the event that the Employer fails to make any payment by its respective due date or within the period set forth in the Contract, the Employer shall pay to the Contractor interest on the amount of such delayed payment at the rate(s) shown in the corresponding Appendix (Terms and Procedures of Payment) to the Agreement for the period of delay until payment has been made in full, whether before or after judgment or arbitration award.
		13.4	The currency or currencies in which payments are made to the Contractor under this Contract shall be specified in the corresponding Appendix (Terms and Procedures of Payment) to the Agreement, subject to the general principle

			that payments will be made in the currency or currencies in which the Contract Price has been stated in the Contractor's Tendering.
		13.5	All payments shall be made in the currency or currencies specified in the corresponding Appendix (Terms and Procedures of Payment) to the Agreement, pursuant to GCC 13.4.
14.	Securities	14.1	<u>Issuance of Securities</u> The Contractor shall provide the securities specified below in favor of the Employer at the times, and in the amount, manner and form specified below.
		14.2	<u>Advance Payment Security</u> 14.2.1 The Contractor shall, within fourteen (14) working days of the notification of contract award, provide a security in an amount equal to the advance payment calculated in accordance with the corresponding Appendix (Terms and Procedures of Payment) to the Agreement, and in the same currency or currencies. 14.2.2 The security shall be in the form provided in the tendering documents or in another form acceptable to the Employer. The amount of the security shall be reduced in proportion to the value of the Facilities executed by and paid to the Contractor from time to time, and shall automatically become null and void when the full amount of the advance payment has been recovered by the Employer. The security shall be returned to the Contractor immediately after its expiration.
		14.3	<u>Performance Security</u> 14.3.1 The Performance Security shall be provided to the Employer no later than the date specified in the Letter of Acceptance and shall be issued in an amount and form and by a bank or surety acceptable to the Employer, and denominated in the types and proportions of the currencies in which the Contract Price is payable as specified in the TDS and SCC and in accordance with the conditions of contract. 14.3.2 The Performance Security shall be valid until a date 28 days from the date of issue of the Certificate of Completion in the case of a Bank Guarantee, and until one year from the date of issue of the Completion Certificate in the case of a Performance Bond. 14.3.3 Where circumstances necessitate the amendment of the contract after signature, and such amendment is effected, the Employer shall require the Contractor to provide additional Performance Security to cover any

			<p>cumulative increase of more than ten percent of the Initial Contract Price.</p> <p>14.3.4 The security shall be denominated in the currency or currencies of the Contract, or in a freely convertible currency acceptable to the Employer, and shall be in one of the forms of bank guarantees provided in the tendering documents, as stipulated by the Employer in the SCC, or in another form acceptable to the Employer.</p> <p>14.3.5 The security shall automatically be reduced by half on the date of the Operational Acceptance and shall become null and void, eighteen (18) months after Completion of the Facilities or twelve (12) months after Operational Acceptance of the Facilities, whichever occurs first; provided, however, that if the Defects Liability Period has been extended on any part of the Facilities pursuant to GCC 28.8 hereof, the Contractor shall issue an additional security in an amount proportionate to the Contract Price of that part. The security shall be returned to the Contractor immediately after its expiration, provided, however, that if the Contractor, pursuant to GCC 28.10, is liable for an extended warranty obligation, the performance security shall be extended for the period and up to the amount specified in the SCC.</p>
15.	Taxes and Duties	15.1	<p>Except as otherwise specifically provided in the Contract, the Contractor shall bear and pay all taxes, duties, levies and charges assessed on the Contractor, its Subcontractors or their employees by all municipal, state or national government authorities in connection with the Facilities in and outside of the United Republic of Tanzania where the Site is located.</p>
		15.2	<p>Notwithstanding GCC 15.1 above, the Employer shall bear and promptly pay all customs and import duties as well as other local taxes like, e.g., a value added tax (VAT), imposed by the law of the United Republic of Tanzania on the Goods specified in Price Schedule No. 1 and that are to be incorporated into the Facilities.</p>
		15.3	<p>If any tax exemptions, reductions, allowances or privileges may be available to the Contractor in the United Republic of Tanzania, the Employer shall use its best endeavors to enable the Contractor to benefit from any such tax savings to the maximum allowable extent.</p>

		15.4	For the purpose of the Contract, it is agreed that the Contract Price specified in Article 2 (Contract Price and Terms of Payment) of the Form of Agreement is based on the taxes, duties, levies and charges prevailing at the date twenty-eight (28) days prior to the date of tender submission in the United Republic of Tanzania (hereinafter called "Tax" in this GCC 15.4). If any rates of Tax are increased or decreased, a new Tax is introduced, an existing Tax is abolished, or any change in interpretation or application of any Tax occurs in the course of the performance of Contract, which was or will be assessed on the Contractor, Subcontractors or their employees in connection with performance of the Contract, an equitable adjustment of the Contract Price shall be made to fully take into account any such change by addition to the Contract Price or deduction there from, as the case may be, in accordance with GCC 37 hereof.
--	--	------	---

D. Intellectual Property

16.	Patent and Copyright	16.1	The Supplier shall indemnify the PE against all third-party claims of infringement of patent, trademark, or industrial design rights arising from use of the Goods or any part thereof in the United Republic of Tanzania.
		16.2	The copyright in all drawings, documents and other materials containing data and information furnished to the Employer by the Contractor herein shall remain vested in the Contractor or, if they are furnished to the Employer directly or through the Contractor by any third party, including suppliers of materials, the copyright in such materials shall remain vested in such third party.
17.	Confidential information	17.1	The Employer and the Contractor shall keep confidential and shall not, without the written consent of the other party hereto, divulge to any third party any documents, data or other information furnished directly or indirectly by the other party hereto in connection with the Contract, whether such information has been furnished prior to, during or following termination of the Contract. Notwithstanding the above, the Contractor may furnish to its Subcontractor(s) such documents, data and other information it receives from the Employer to the extent required for the Subcontractor(s) to perform its work under the Contract, in which event the Contractor shall obtain from such Subcontractor(s) an undertaking of confidentiality similar to that imposed on the Contractor under this GCC 17.
		17.2	The Employer shall not use such documents, data and other information received from the Contractor for any purpose other than the operation and maintenance of the Facilities.

			Similarly, the Contractor shall not use such documents, data and other information received from the Employer for any purpose other than the design, procurement of Goods, construction or such other work and services as are required for the performance of the Contract.
		17.3	The obligation of a party under GCCs 17.1 and 17.2 above, however, shall not apply to that information which <ul style="list-style-type: none"> (a) now or hereafter enters the public domain through no fault of that party (b) can be proven to have been possessed by that party at the time of disclosure and which was not previously obtained, directly or indirectly, from the other party hereto (c) otherwise lawfully becomes available to that party from a third party that has no obligation of confidentiality.
		17.4	The above provisions of this GCC 17 shall not in any way modify any undertaking of confidentiality given by either of the parties hereto prior to the date of the Contract in respect of the Facilities or any part thereof.
		17.5	The provisions of this GCC 17 shall survive termination, for whatever reason, of the Contract.

E. Execution of the Facilities

18.	Representatives	18.1	<p><u>Project Manager</u></p> <p>If the Project Manager is not named in the Contract, then within Seven (7) working days of the Effective Date, the Employer shall appoint and notify the Contractor in writing of the name of the Project Manager. The Employer may from time to time appoint some other person as the Project Manager in place of the person previously so appointed, and shall give a notice of the name of such other person to the Contractor without delay. No such appointment shall be made at such a time or in such a manner as to impede the progress of work on the Facilities. Such appointment shall only take effect upon receipt of such notice by the Contractor. The Project Manager shall represent and act for the Employer at all times during the currency of the Contract. All notices, instructions, orders, certificates, approvals and all other communications under the Contract shall be given by the Project Manager, except as herein otherwise provided.</p> <p>All notices, instructions, information and other communications given by the Contractor to the Employer</p>

		<p>under the Contract shall be given to the Project Manager, except as herein otherwise provided.</p> <p>18.2 Contractor's Representative & Project Manager</p> <p>18.2.1 If the Contractor's Representative is not named in the Contract, then within Seven (7) working days of the Effective Date, the Contractor shall appoint the Contractor's Representative and shall request the Employer in writing to approve the person so appointed. If the Employer makes no objection to the appointment within Seven (7) working days, the Contractor's Representative shall be deemed to have been approved. If the Employer objects to the appointment within Seven (7) working days giving the reason thereof, then the Contractor shall appoint a replacement within Seven (7) working days of such objection, and the foregoing provisions of this GCC 18.2.1 shall apply thereto.</p> <p>18.2.2 The Contractor's Representative shall represent and act for the Contractor at all times during the currency of the Contract and shall give to the Project Manager all the Contractor's notices, instructions, information and all other communications under the Contract.</p> <p>18.2.3 All notices, instructions, information and all other communications given by the Employer or the Project Manager to the Contractor under the Contract shall be given to the Contractor's Representative or, in its absence, its deputy, except as herein otherwise provided.</p> <p>18.2.4 The Contractor shall not revoke the appointment of the Contractor's Representative without the Employer's prior written consent, which shall not be unreasonably withheld. If the Employer consents thereto, the Contractor shall appoint some other person as the Contractor's Representative, pursuant to the procedure set out in GCC 18.2.1.</p> <p>18.2.5 The Contractor's Representative may, subject to the approval of the Employer (which shall not be unreasonably withheld), at any time delegate to any person any of the powers, functions and authorities vested in him or her. Any such delegation may be revoked at any time. Any such delegation or revocation shall be subject to a prior notice signed by the Contractor's Representative, and shall specify the powers, functions and authorities thereby delegated or revoked. No such delegation</p>
--	--	---

			<p>or revocation shall take effect unless and until a copy thereof has been delivered to the Employer and the Project Manager.</p> <p>Any act or exercise by any person of powers, functions and authorities so delegated to him or her in accordance with this GCC 18.2.3 shall be deemed to be an act or exercise by the Contractor's Representative.</p> <p>18.2.6 From the commencement of installation of the Facilities at the Site until Completion, the Contractor's Representative shall appoint a suitable person as the construction manager (hereinafter referred to as "the Construction Manager"). The Construction Manager shall supervise all work done at the Site by the Contractor and shall be present at the Site throughout normal working hours except when on leave, sick or absent for reasons connected with the proper performance of the Contract. Whenever the Construction Manager is absent from the Site, a suitable person shall be appointed to act as his or her deputy.</p> <p>18.2.7 The Employer may by notice to the Contractor object to any representative or person employed by the Contractor in the execution of the Contract who, in the reasonable opinion of the Employer, may behave inappropriately, may be incompetent or negligent, or may commit a serious breach of the Site regulations provided under GCC 23.3. The Employer shall provide evidence of the same, whereupon the Contractor shall remove such person from the Facilities.</p> <p>18.2.6 If any representative or person employed by the Contractor is removed in accordance with GCC 18.2.5, the Contractor shall, where required, promptly appoint a replacement.</p>
19.	Work Programme	19.1	<p><u>Contractor's Organization</u></p> <p>The Contractor shall supply to the Employer and the Project Manager a chart showing the proposed organization to be established by the Contractor for carrying out work on the Facilities. The chart shall include the identities of the key personnel together with the curricula vitae of such key personnel to be employed within twenty-one (21) days of the Effective Date. The Contractor shall promptly inform the Employer and the Project Manager in writing of any revision or alteration of such an organization chart.</p>

		19.2	<p><u>Programme of Performance</u> Within twenty-eight (28) days after the date of signing the Agreement, the Contractor shall prepare and submit to the Project Manager a detailed programme of performance of the Contract, made in the form specified in the SCC and showing the sequence in which it proposes to design, manufacture, transport, assemble, install and pre-commission the Facilities, as well as the date by which the Contractor reasonably requires that the Employer shall have fulfilled its obligations under the Contract so as to enable the Contractor to execute the Contract in accordance with the programme and to achieve Completion, Commissioning and Acceptance of the Facilities in accordance with the Contract. The programme so submitted by the Contractor shall accord with the Time Schedule included in the corresponding Appendix (Time Schedule) to the Agreement and any other dates and periods specified in the Contract. The Contractor shall update and revise the programme as and when appropriate or when required by the Project Manager, but without modification in the Times for Completion given in the SCC and any extension granted in accordance with GCC 41, and shall submit all such revisions to the Project Manager.</p>
		19.3	<p><u>Progress Report</u> The Contractor shall monitor progress of all the activities specified in the programme referred to in GCC 19.2 above, and supply a progress report to the Project Manager every month. The progress report shall be in a form acceptable to the Project Manager and shall indicate: (a) percentage completion achieved compared with the planned percentage completion for each activity; and (b) where any activity is behind the programme, giving comments and likely consequences and stating the corrective action being taken.</p>
		19.4	<p><u>Progress of Performance</u> If at any time the Contractor's actual progress falls behind the programme referred to in GCC 19.2, or it becomes apparent that it will so fall behind, the Contractor shall, at the request of the Employer or the Project Manager, prepare and submit to the Project Manager a revised programme, taking into account the prevailing circumstances, and shall notify the Project Manager of the steps being taken to expedite progress so as to attain Completion of the Facilities within the Time for Completion under GCC 8.2, any extension thereof entitled under GCC 41.1, or any extended period as may otherwise be agreed upon between the Employer and the Contractor.</p>

		19.5	<p><u>Work Procedures</u></p> <p>The Contract shall be executed in accordance with the Contract Documents and the procedures given in the section on Sample Forms and Procedures of the Contract Documents.</p> <p>The Contractor may execute the Contract in accordance with its own standard project execution plans and procedures to the extent that they do not conflict with the provisions contained in the Contract.</p>
20.	Subcontracting	20.1	<p>The corresponding Appendix (List of Approved Subcontractors) to the Agreement specifies major items of supply or services and a list of approved Subcontractors against each item, including vendors. Insofar as no Subcontractors are listed against any such item, the Contractor shall prepare a list of Subcontractors for such item for inclusion in such list. The Contractor may from time to time propose any addition to or deletion from any such list. The Contractor shall submit any such list or any modification thereto to the Employer for its approval in sufficient time so as not to impede the progress of work on the Facilities. Such approval by the Employer for any of the Subcontractors shall not relieve the Contractor from any of its obligations, duties or responsibilities under the Contract.</p>
		20.2	<p>The Contractor shall select and employ its Subcontractors for such major items from those listed in the lists referred to in GCC 20.1.</p>
		20.3	<p>For items or parts of the Facilities not specified in the corresponding Appendix (List of Approved Subcontractors) to the Agreement, the Contractor may employ such Subcontractors as it may select, at its discretion.</p>
21.	Design and Engineering	21.1	<p><u>Specifications and Drawings</u></p> <p>21.1.1 The Contractor shall execute the basic and detailed design and the engineering work in compliance with the provisions of the Contract, or where not so specified, in accordance with good engineering practice.</p> <p>The Contractor shall be responsible for any discrepancies, errors or omissions in the specifications, drawings and other technical documents that it has prepared, whether such specifications, drawings and other documents have been approved by the Project Manager or not, provided that such discrepancies, errors or omissions are not because of</p>

			<p>inaccurate information furnished in writing to the Contractor by or on behalf of the Employer.</p> <p>21.1.2 The Contractor shall be entitled to disclaim responsibility for any design, data, drawing, specification or other document, or any modification thereof provided or designated by or on behalf of the Employer, by giving a notice of such disclaimer to the Project Manager.</p>
		21.2	<p><u>Codes and Standards</u></p> <p>Wherever references are made in the Contract to codes and standards in accordance with which the Contract shall be executed, the edition or the revised version of such codes and standards current at the date twenty-eight (28) days prior to date of tender submission shall apply unless otherwise specified. During Contract execution, any changes in such codes and standards shall be applied after approval by the Employer and shall be treated in accordance with GCC 40.</p>
		21.3	<p><u>Approval/Review of Technical Documents by Project Manager</u></p> <p>21.3.1 The Contractor shall prepare (or cause its Subcontractors to prepare) and furnish to the Project Manager the documents listed in the corresponding Appendix (List of Documents for Approval or Review) to the Agreement for its approval or review as specified and in accordance with the requirements of GCC 19.2 (Programme of Performance).</p> <p>Any part of the Facilities covered by or related to the documents to be approved by the Project Manager shall be executed only after the Project Manager's approval thereof.</p> <p>GCCs 21.3.2 through 21.3.7 shall apply to those documents requiring the Project Manager's approval, but not to those furnished to the Project Manager for its review only.</p> <p>21.3.2 Within fourteen (14) days after receipt by the Project Manager of any document requiring the Project Manager's approval in accordance with GCC 21.3.1, the Project Manager shall either return one copy thereof to the Contractor with its approval endorsed thereon or shall notify the Contractor in writing of its disapproval thereof and the reasons therefore and the modifications that the Project Manager proposes.</p>

If the Project Manager fails to take such action within the said fourteen (14) working days, then the said document shall be deemed to have been approved by the Project Manager.

21.3.3 The Project Manager shall not disapprove any document, except on the grounds that the document does not comply with some specified provision of the Contract or that it is contrary to good engineering practice.

21.3.4 If the Project Manager disapproves the document, the Contractor shall modify the document and resubmit it for the Project Manager's approval in accordance with GCC 21.3.2. If the Project Manager approves the document subject to modification(s), the Contractor shall make the required modification(s), whereupon the document shall be deemed to have been approved.

21.3.5 If any dispute or difference occurs between the Employer and the Contractor in connection with or arising out of the disapproval by the Project Manager of any document and/or any modification(s) thereto that cannot be settled between the parties within a reasonable period, then such dispute or difference may be referred to an Adjudicator for determination in accordance with GCC 6.1 hereof. If such dispute or difference is referred to an Adjudicator, the Project Manager shall give instructions as to whether and if so, how, performance of the Contract is to proceed. The Contractor shall proceed with the Contract in accordance with the Project Manager's instructions, provided that if the Adjudicator upholds the Contractor's view on the dispute and if the Employer has not given notice under GCC 6.1.2 hereof, then the Contractor shall be reimbursed by the Employer for any additional costs incurred by reason of such instructions and shall be relieved of such responsibility or liability in connection with the dispute and the execution of the instructions as the Adjudicator shall decide, and the Time for Completion shall be extended accordingly.

21.3.6 The Project Manager's approval, with or without modification of the document furnished by the Contractor, shall not relieve the Contractor of any responsibility or liability imposed upon it by any provisions of the Contract except to the extent that

			<p>any subsequent failure results from modifications required by the Project Manager.</p> <p>21.3.7 The Contractor shall not depart from any approved document unless the Contractor has first submitted to the Project Manager an amended document and obtained the Project Manager's approval thereof, pursuant to the provisions of this GCC 21.3.</p> <p>21.3.8 If the Project Manager requests any change in any already approved document and/or in any document based thereon, the provisions of GCC 40 shall apply to such request.</p>
22.	Procurement	22.1	<p><u>Goods</u></p> <p>Subject to GCC 15.2, the Contractor shall manufacture or procure and transport all the Goods in an expeditious and orderly manner to the Site.</p>
		22.2	<p><u>Employer-Supplied Plant, Equipment, and Materials</u></p> <p>If the corresponding Appendix (Scope of Works and Supply by the Employer) to the Agreement provides that the Employer shall furnish any specific items of machinery, equipment or materials to the Contractor, the following provisions shall apply:</p> <p>22.2.1 The Employer shall, at its own risk and expense, transport each item to the place on or near the Site as agreed upon by the parties and make such item available to the Contractor at the time specified in the programme furnished by the Contractor, pursuant to GCC 19.2, unless otherwise mutually agreed.</p> <p>22.2.2 Upon receipt of such item, the Contractor shall inspect the same visually and notify the Project Manager of any detected shortage, defect or default. The Employer shall immediately remedy any shortage, defect or default, or the Contractor shall, if practicable and possible, at the request of the Employer, remedy such shortage, defect or default at the Employer's cost and expense. After inspection, such item shall fall under the care, custody and control of the Contractor. The provision of this GCC 22.2.2 shall apply to any item supplied to remedy any such shortage or default or to substitute for any defective item, or shall apply to defective items that have been repaired.</p>

			<p>22.2.3 The foregoing responsibilities of the Contractor and its obligations of care, custody and control shall not relieve the Employer of liability for any undetected shortage, defect or default, nor place the Contractor under any liability for any such shortage, defect or default whether under GCC 28 or under any other provision of Contract.</p>
		22.3	<p><u>Transportation</u></p> <p>22.3.1 The Contractor shall at its own risk and expense transport all the Goods and the Contractor's Equipment to the Site by the mode of transport that the Contractor judges most suitable under all the circumstances.</p> <p>22.3.2 Unless otherwise provided in the Contract, the Contractor shall be entitled to select any safe mode of transport operated by any person to carry the Goods and the Contractor's Equipment.</p> <p>22.3.3 Upon dispatch of each shipment of the Goods and the Contractor's Equipment, the Contractor shall notify the Employer by telex, cable, facsimile or Electronic Data Interchange (EDI) of the description of the Goods and of the Contractor's Equipment, the point and means of dispatch, and the estimated time and point of arrival in the United Republic of Tanzania, if applicable, and at the Site. The Contractor shall furnish the Employer with relevant shipping documents to be agreed upon between the parties.</p> <p>22.3.4 The Contractor shall be responsible for obtaining, if necessary, approvals from the authorities for transportation of the Goods and the Contractor's Equipment to the Site. The Employer shall use its best endeavors in a timely and expeditious manner to assist the Contractor in obtaining such approvals, if requested by the Contractor. The Contractor shall indemnify and hold harmless the Employer from and against any claim for damage to roads, bridges or any other traffic facilities that may be caused by the transport of the Goods and the Contractor's Equipment to the Site.</p>
		22.4	<p><u>Customs Clearance</u></p> <p>The Contractor shall, at its own expense, handle all imported Goods and Contractor's Equipment at the point(s) of import and shall handle any formalities for customs clearance, subject to the Employer's obligations under GCC 15 2, provided that if applicable laws or regulations</p>

			require any application or act to be made by or in the name of the Employer, the Employer shall take all necessary steps to comply with such laws or regulations. In the event of delays in customs clearance that are not the fault of the Contractor, the Contractor shall be entitled to an extension in the Time for Completion, pursuant to GCC 41.
23.	Installation	23.1	<p><u>Setting Out/Supervision/Labour</u></p> <p>23.1.1 <i>Bench Mark</i>: The Contractor shall be responsible for the true and proper setting-out of the Facilities in relation to bench marks, reference marks and lines provided to it in writing by or on behalf of the Employer.</p> <p>If, at any time during the progress of installation of the Facilities, any error shall appear in the position, level or alignment of the Facilities, the Contractor shall forthwith notify the Project Manager of such error and, at its own expense, immediately rectify such error to the reasonable satisfaction of the Project Manager. If such error is based on incorrect data provided in writing by or on behalf of the Employer, the expense of rectifying the same shall be borne by the Employer.</p> <p>23.1.2 <i>Contractor's Supervision</i>: The Contractor shall give or provide all necessary superintendence during the installation of the Facilities, and the Construction Manager or its deputy shall be constantly on the Site to provide full-time superintendence of the installation. The Contractor shall provide and employ only technical personnel who are skilled and experienced in their respective callings and supervisory staff who are competent to adequately supervise the work at hand.</p> <p>23.1.3 <i>Labour</i>:</p> <p>(a) The Contractor shall provide and employ on the Site in the installation of the Facilities such skilled, semi-skilled and unskilled labour as is necessary for the proper and timely execution of the Contract. The Contractor is encouraged to use local labour that has the necessary skills.</p> <p>(b) Unless otherwise provided in the Contract, the Contractor shall be responsible for the recruitment, transportation, accommodation and catering of all labour, local or expatriate, required for the execution of the Contract and for all payments in connection therewith.</p>

JS

			<p>(c) The Contractor shall be responsible for obtaining all necessary permit(s) and/or visa(s) from the appropriate authorities for the entry of all labour and personnel to be employed on the Site into the United Republic of Tanzania and in the exact region where the Site is located.</p> <p>(d) The Contractor shall at its own expense provide the means of repatriation to all of its and its Subcontractor's personnel employed on the Contract at the Site to their various home countries. It shall also provide suitable temporary maintenance of all such persons from the cessation of their employment on the Contract to the date programmed for their departure. In the event that the Contractor defaults in providing such means of transportation and temporary maintenance, the Employer may provide the same to such personnel and recover the cost of doing so from the Contractor.</p> <p>(e) The Contractor shall at all times during the progress of the Contract use its best endeavors to prevent any unlawful, riotous or disorderly conduct or behavior by or amongst its employees and the labour of its Subcontractors.</p> <p>(f) The Contractor shall, in all dealings with its labour and the labour of its Subcontractors currently employed on or connected with the Contract, pay due regard to all recognized festivals, official holidays, religious or other customs and all local laws and regulations pertaining to the employment of labour.</p>
		23.2	<p><u>Contractor's Equipment</u></p> <p>23.2.1 All Contractor's Equipment brought by the Contractor onto the Site shall be deemed to be intended to be used exclusively for the execution of the Contract. The Contractor shall not remove the same from the Site without the Project Manager's consent that such Contractor's Equipment is no longer required for the execution of the Contract.</p> <p>23.2.2 Unless otherwise specified in the Contract, upon completion of the Facilities, the Contractor shall remove from the Site all Equipment brought by the Contractor onto the Site and any surplus materials remaining thereon.</p>

			<p>23.2.3 The Employer will, if requested, use its best endeavors to assist the Contractor in obtaining any local, state or national government permission required by the Contractor for the export of the Contractor's Equipment imported by the Contractor for use in the execution of the Contract that is no longer required for the execution of the Contract.</p>
		23.3	<p><u>Site Regulations and Safety</u> The Employer and the Contractor shall establish Site regulations setting out the rules to be observed in the execution of the Contract at the Site and shall comply therewith. The Contractor shall prepare and submit to the Employer, with a copy to the Project Manager, proposed Site regulations for the Employer's approval, which approval shall not be unreasonably withheld.</p> <p>Such Site regulations shall include, but shall not be limited to, rules in respect of security, safety of the Facilities, gate control, sanitation, medical care, and fire prevention.</p>
		23.4	<p><u>Opportunities for Other Contractors</u> 23.4.1 The Contractor shall, upon written request from the Employer or the Project Manager, give all reasonable opportunities for carrying out the work to any other contractors employed by the Employer on or near the Site.</p> <p>23.4.2 If the Contractor, upon written request from the Employer or the Project Manager, makes available to other contractors any roads or ways the maintenance for which the Contractor is responsible, permits the use by such other contractors of the Contractor's Equipment, or provides any other service of whatsoever nature for such other contractors, the Employer shall fully compensate the Contractor for any loss or damage caused or occasioned by such other contractors in respect of any such use or service, and shall pay to the Contractor reasonable remuneration for the use of such equipment or the provision of such services.</p> <p>23.4.3 The Contractor shall also so arrange to perform its work as to minimize, to the extent possible, interference with the work of other contractors. The Project Manager shall determine the resolution of any difference or conflict that may arise between the Contractor and other contractors and the workers of the Employer in regard to their work.</p>

			<p>23.4.4 The Contractor shall notify the Project Manager promptly of any defects in the other contractors' work that come to its notice, and that could affect the Contractor's work. The Project Manager shall determine the corrective measures, if any, required to rectify the situation after inspection of the Facilities. Decisions made by the Project Manager shall be binding on the Contractor.</p>
		23.5	<p><u>Emergency Work</u> If, by reason of an emergency arising in connection with and during the execution of the Contract, any protective or remedial work is necessary as a matter of urgency to prevent damage to the Facilities, the Contractor shall immediately carry out such work.</p> <p>If the Contractor is unable or unwilling to do such work immediately, the Employer may do or cause such work to be done as the Employer may determine is necessary in order to prevent damage to the Facilities. In such event the Employer shall, as soon as practicable after the occurrence of any such emergency, notify the Contractor in writing of such emergency, the work done and the reasons therefore. If the work done or caused to be done by the Employer is work that the Contractor was liable to do at its own expense under the Contract, the reasonable costs incurred by the Employer in connection therewith shall be paid by the Contractor to the Employer. Otherwise, the cost of such remedial work shall be borne by the Employer.</p>
		23.6	<p><u>Site Clearance</u> 23.6.1 <i>Site Clearance in Course of Performance.</i> In the course of carrying out the Contract, the Contractor shall keep the Site reasonably free from all unnecessary obstruction, store or remove any surplus materials, clear away any wreckage, rubbish or temporary works from the Site, and remove any Contractor's Equipment no longer required for execution of the Contract.</p> <p>23.6.1 <i>Clearance of Site after Completion.</i> After Completion of all parts of the Facilities, the Contractor shall clear away and remove all wreckage, rubbish and debris of any kind from the Site, and shall leave the Site and Facilities clean and safe.</p>
		23.7	<p><u>Watching and Lighting</u> The Contractor shall provide and maintain at its own expense all lighting, fencing, and watching when and</p>

			where necessary for the proper execution and the protection of the Facilities, or for the safety of the owners and occupiers of adjacent property and for the safety of the public.
		23.8	<p><u>Work at Night and on Holidays</u></p> <p>23.8.1 Unless otherwise provided in the Contract, no work shall be carried out during the night and on public holidays of the United Republic of Tanzania without prior written consent of the Employer, except where work is necessary or required to ensure safety of the Facilities or for the protection of life, or to prevent loss or damage to property, when the Contractor shall immediately advise the Project Manager, provided that provisions of this GCC 23.8.1 shall not apply to any work which is customarily carried out by rotary or double-shifts.</p> <p>23.8.2 Notwithstanding GCCs 23.8.1 or 22.1.3, if and when the Contractor considers it necessary to carry out work at night or on public holidays so as to meet the Time for Completion and requests the Employer's consent thereto, the Employer shall not unreasonably withhold such consent.</p>
24.	Test and Inspection	24.1	The Contractor shall at its own expense carry out at the place of manufacture and/or on the Site all such tests and/or inspections of the Goods and any part of the Facilities as are specified in the Contract.
		24.2	The Employer and the Project Manager or their designated representatives shall be entitled to attend the aforesaid test and/or inspection, provided that the Employer shall bear all costs and expenses incurred in connection with such attendance including, but not limited to, all traveling and board and lodging expenses.
		24.3	Whenever the Contractor is ready to carry out any such test and/or inspection, the Contractor shall give a reasonable advance notice of such test and/or inspection and of the place and time thereof to the Project Manager. The Contractor shall obtain from any relevant third party or manufacturer any necessary permission or consent to enable the Employer and the Project Manager (or their designated representatives) to attend the test and/or inspection.
		24.4	The Contractor shall provide the Project Manager with a certified report of the results of any such test and/or inspection.

			If the Employer or Project Manager (or their designated representatives) fails to attend the test and/or inspection, or if it is agreed between the parties that such persons shall not do so, then the Contractor may proceed with the test and/or inspection in the absence of such persons, and may provide the Project Manager with a certified report of the results thereof.
		24.5	The Project Manager may require the Contractor to carry out any test and/or inspection not required by the Contract, provided that the Contractor's reasonable costs and expenses incurred in the carrying out of such test and/or inspection shall be added to the Contract Price. Further, if such test and/or inspection impedes the progress of work on the Facilities and/or the Contractor's performance of its other obligations under the Contract, due allowance will be made in respect of the Time for Completion and the other obligations so affected
		24.6	If any Goods or any part of the Facilities fails to pass any test and/or inspection, the Contractor shall either rectify or replace such Goods or part of the Facilities and shall repeat the test and/or inspection upon giving a notice under GCC 24.3.
		24.7	If any dispute or difference of opinion shall arise between the parties in connection with or arising out of the test and/or inspection of the Goods or part of the Facilities that cannot be settled between the parties within a reasonable period of time, it may be referred to an Adjudicator for determination in accordance with GCC 6.1.
		24.8	The Contractor shall afford the Employer and the Project Manager, at the Employer's expense, access at any reasonable time to any place where the Goods are being manufactured or the Facilities are being installed, in order to inspect the progress and the manner of manufacture or installation, provided that the Project Manager shall give the Contractor a reasonable prior notice.
		24.9	The Contractor agrees that neither the execution of a test and/or inspection of Goods or any part of the Facilities, nor the attendance by the Employer or the Project Manager, nor the issue of any test certificate pursuant to GCC 24.4, shall release the Contractor from any other responsibilities under the Contract.
		24.10	No part of the Facilities or foundations shall be covered up on the Site without the Contractor carrying out any test and/or inspection required under the Contract. The Contractor shall give a reasonable notice to the Project Manager whenever any such ready or about to be ready

			for test and/or inspection; such test and/or inspection and notice thereof shall be subject to the requirements of the Contract.
		24.11	<p>The Contractor shall uncover any part of the Facilities or foundations, or shall make openings in or through the same as the Project Manager may from time to time require at the Site, and shall reinstate and make good such part or parts.</p> <p>If any parts of the Facilities or foundations have been covered up at the Site after compliance with the requirement of GCC 24.10 and are found to be executed in accordance with the Contract, the expenses of uncovering, making openings in or through, reinstating, and making good the same shall be borne by the Employer, and the Time for Completion shall be reasonably adjusted to the extent that the Contractor has thereby been delayed or impeded in the performance of any of its obligations under the Contract.</p>
25.	Completion of the Facilities	25.1	As soon as the Facilities or any part thereof has, in the opinion of the Contractor, been completed operationally and structurally and put in a tight and clean condition as specified in the Technical Specifications, excluding minor items not materially affecting the operation or safety of the Facilities, the Contractor shall so notify the Employer in writing.
		25.2	<p>Within seven (7) working days after receipt of the notice from the Contractor under GCC 25.1, the Employer shall supply the operating and maintenance personnel specified in the corresponding Appendix (Scope of Works and Supply by the Employer) to the Agreement for Pre-commissioning of the Facilities or any part thereof.</p> <p>Pursuant to the corresponding Appendix (Scope of Works and Supply by the Employer) to the Agreement, the Employer shall also provide, within the said seven (7) day period, the raw materials, utilities, lubricants, chemicals, catalysts, facilities, services and other matters required for Pre-commissioning of the Facilities or any part thereof.</p>
		25.3	As soon as reasonably practicable after the operating and maintenance personnel have been supplied by the Employer and the raw materials, utilities, lubricants, chemicals, catalysts, facilities, services and other matters have been provided by the Employer in accordance with GCC 25.2, the Contractor shall commence Pre-

			commissioning of the Facilities or the relevant part thereof in preparation for Commissioning.
		25.4	As soon as all works in respect of Pre-commissioning are completed and, in the opinion of the Contractor, the Facilities or any part thereof is ready for Commissioning, the Contractor shall so notify the Project Manager in writing.
		25.5	<p>The Project Manager shall, within fourteen (14) days after receipt of the Contractor's notice under GCC 25.4, either issue a Completion Certificate in the form specified in the Sample Forms and Procedures section in the tendering documents, stating that the Facilities or that part thereof have reached Completion as of the date of the Contractor's notice under GCC 245.4, or notify the Contractor in writing of any defects and/or deficiencies.</p> <p>If the Project Manager notifies the Contractor of any defects and/or deficiencies, the Contractor shall then correct such defects and/or deficiencies, and shall repeat the procedure described in GCC 25.4.</p> <p>If the Project Manager is satisfied that the Facilities or that part thereof have reached Completion, the Project Manager shall, within seven (7) days after receipt of the Contractor's repeated notice, issue a Completion Certificate stating that the Facilities or that part thereof have reached Completion as of the date of the Contractor's repeated notice.</p> <p>If the Project Manager is not so satisfied, then it shall notify the Contractor in writing of any defects and/or deficiencies within seven (7) days after receipt of the Contractor's repeated notice, and the above procedure shall be repeated.</p>
		25.6	If the Project Manager fails to issue the Completion Certificate and fails to inform the Contractor of any defects and/or deficiencies within fourteen (14) days after receipt of the Contractor's notice under GCC 25.4 or within seven (7) days after receipt of the Contractor's repeated notice under GCC 25.5, or if the Employer makes use of the Facilities or part thereof, then the Facilities or that part thereof shall be deemed to have reached Completion as of the date of the Contractor's notice or repeated notice, or as of the Employer's use of the Facilities, as the case may be.
		25.7	As soon as possible after Completion, the Contractor shall complete all outstanding minor items so that the Facilities are fully in accordance with the requirements of the

			Contract, failing which the Employer will undertake such completion and deduct the costs thereof from any monies owing to the Contractor.
		25.8	Upon Completion, the Employer shall be responsible for the care and custody of the Facilities or the relevant part thereof, together with the risk of loss or damage thereto, and shall thereafter take over the Facilities or the relevant part thereof.
26.	Commissioning and Operational Acceptance	26.1	<p><u>Commissioning</u></p> <p>26.1.1 Commissioning of the Facilities or any part thereof shall be commenced by the Contractor immediately after issue of the Completion Certificate by the Project Manager, pursuant to GCC 25.5, or immediately after issue of the deemed Completion, under GCC 25.6.</p> <p>26.1.2 The Employer shall supply the operating and maintenance personnel and all raw materials, utilities, lubricants, chemicals, catalysts, facilities, services and other matters required for Commissioning.</p>
		26.2	<p><u>Guarantee Test</u></p> <p>26.2.1 The Guarantee Test (and repeats thereof) shall be conducted by the Contractor during Commissioning of the Facilities or the relevant part thereof to ascertain whether the Facilities or the relevant part can attain the Functional Guarantees specified in the Technical Specifications. The Contractor's and Project Manager's advisory personnel shall attend the Guarantee Test, and shall advise and assist the Employer. The Employer shall promptly provide the Contractor with such information as the Contractor may reasonably require in relation to the conduct and results of the Guarantee Test (and any repeats thereof).</p> <p>26.2.2 If for reasons not attributable to the Contractor, the Guarantee Test of the Facilities or the relevant part thereof cannot be successfully completed within the period from the date of Completion specified in the SCC or any other period agreed upon by the Employer and the Contractor, the Contractor shall be deemed to have fulfilled its obligations with respect to the Functional Guarantees, and GCCs 29.2 and 28.3 shall not apply.</p>
		26.3	<u>Operational Acceptance</u>

			<p>26.3.1 Subject to GCC 26.4 below, Operational Acceptance shall occur in respect of the Facilities or any part thereof when</p> <ul style="list-style-type: none"> (a) the Guarantee Test has been successfully completed and the Functional Guarantees are met; or (b) the Guarantee Test has not been successfully completed or has not been carried out for reasons not attributable to the Contractor within the period from the date of Completion specified in the SCC or any other agreed upon period as specified in GCC 26.2.2 above; or (c) the Contractor has paid the liquidated damages specified in GCC 29.3 hereof; and (d) any minor items mentioned in GCC 24.7 hereof relevant to the Facilities or that part thereof have been completed. <p>26.3.2 At any time after any of the events set out in GCC 26.3.1 have occurred, the Contractor may give a notice to the Project Manager requesting the issue of an Operational Acceptance Certificate in the form provided in the Tendering Documents or in another form acceptable to the Employer in respect of the Facilities or the part thereof specified in such notice as of the date of such notice.</p> <p>26.3.3 The Project Manager shall, after consultation with the Employer, and within seven (7) days after receipt of the Contractor's notice, issue an Operational Acceptance Certificate.</p> <p>26.3.4 If within seven (7) days after receipt of the Contractor's notice, the Project Manager fails to issue the Operational Acceptance Certificate or fails to inform the Contractor in writing of the justifiable reasons why the Project Manager has not issued the Operational Acceptance Certificate, the Facilities or the relevant part thereof shall be deemed to have been accepted as of the date of the Contractor's said notice.</p>
		26.4	<p><u>Partial Acceptance</u></p> <p>26.4.1 If the Contract specifies that Completion and Commissioning shall be carried out in respect of</p>

			<p>parts of the Facilities, the provisions relating to Completion and Commissioning including the Guarantee Test shall apply to each such part of the Facilities individually, and the Operational Acceptance Certificate shall be issued accordingly for each such part of the Facilities.</p> <p>26.4.2 If a part of the Facilities comprises facilities such as buildings, for which no Commissioning or Guarantee Test is required, then the Project Manager shall issue the Operational Acceptance Certificate for such facility when it attains Completion, provided that the Contractor shall thereafter complete any outstanding minor items that are listed in the Operational Acceptance Certificate.</p>
--	--	--	---

F. Guarantees and Liabilities

27	Completion Time Guarantee	27.1	<p>The Contractor guarantees that it shall attain Completion of the Facilities (or a part for which a separate time for completion is specified in the SCC) within the Time for Completion specified in the SCC pursuant to GCC 8.2, or within such extended time to which the Contractor shall be entitled under GCC 41 hereof.</p>
		27.2	<p>If the Contractor fails to attain Completion of the Facilities or any part thereof within the Time for Completion or any extension thereof under GCC 41, the Contractor shall pay to the Employer liquidated damages in the amount specified in the SCC as a percentage rate of the Contract Price, or the relevant part thereof. The aggregate amount of such liquidated damages shall in no event exceed the amount specified as "Maximum" in the SCC. Once the "Maximum" is reached, the Employer may consider termination of the Contract, pursuant to GCC 43.2.2.</p> <p>Such payment shall completely satisfy the Contractor's obligation to attain Completion of the Facilities or the relevant part thereof within the Time for Completion or any extension thereof under GCC 41. The Contractor shall have no further liability whatsoever to the Employer in respect thereof.</p> <p>However, the payment of liquidated damages shall not in any way relieve the Contractor from any of its obligations to complete the Facilities or from any other obligations and liabilities of the Contractor under the Contract.</p> <p>Save for liquidated damages payable under this GCC 27.2, the failure by the Contractor to attain any milestone or other act, matter or thing by any date specified in the</p>

			corresponding Appendix (Time Schedule) to the Agreement and/or other programme of work prepared pursuant to GCC 19.2 shall not render the Contractor liable for any loss or damage thereby suffered by the Employer.
		27.3	If the Contractor attains Completion of the Facilities or any part thereof before the Time for Completion or any extension thereof under GCC 41, the Employer shall pay to the Contractor a bonus in the amount specified in the SCC. The aggregate amount of such bonus shall in no event exceed the amount specified as "Maximum" in the SCC.
28.	Defect Liability	28.1	The Contractor warrants that the Facilities or any part thereof shall be free from defects in the design, engineering, materials and workmanship of the Goods supplied and of the work executed.
		28.2	<p>The Defect Liability Period shall be eighteen (18) months from the date of Completion of the Facilities (or any part thereof) or twelve (12) months from the date of Operational Acceptance of the Facilities (or any part thereof), whichever first occurs, unless specified otherwise in the SCC.</p> <p>If during the Defect Liability Period any defect should be found in the design, engineering, materials and workmanship of the Goods supplied or of the work executed by the Contractor, the Contractor shall promptly, in consultation and agreement with the Employer regarding appropriate remedying of the defects, and at its cost, repair, replace or otherwise make good (as the Contractor shall, at its discretion, determine) such defect as well as any damage to the Facilities caused by such defect. The Contractor shall not be responsible for the repair, replacement or making good of any defect or of any damage to the Facilities arising out of or resulting from any of the following causes:</p> <ul style="list-style-type: none"> (a) improper operation or maintenance of the Facilities by the Employer (b) operation of the Facilities outside specifications provided in the Contract (c) normal wear and tear.
		28.3	<p>The Contractor's obligations under this GCC 28 shall not apply to</p> <ul style="list-style-type: none"> (a) any materials that are supplied by the Employer under GCC 22.2, are normally consumed in operation, or have a normal life shorter than the Defect Liability Period stated herein

			<p>(b) any designs, specifications or other data designed, supplied or specified by or on behalf of the Employer or any matters for which the Contractor has disclaimed responsibility herein</p> <p>(c) any other materials supplied or any other work executed by or on behalf of the Employer, except for the work executed by the Employer under GCC 28.7.</p>
		28.4	<p>The Employer shall give the Contractor a notice stating the nature of any such defect together with all available evidence thereof, promptly following the discovery thereof. The Employer shall afford all reasonable opportunity for the Contractor to inspect any such defect.</p>
		28.5	<p>The Employer shall afford the Contractor all necessary access to the Facilities and the Site to enable the Contractor to perform its obligations under this GCC 28.</p> <p>The Contractor may, with the consent of the Employer, remove from the Site any Goods or any part of the Facilities that are defective if the nature of the defect, and/or any damage to the Facilities caused by the defect, is such that repairs cannot be expeditiously carried out at the Site.</p>
		28.6	<p>If the repair, replacement or making good is of such a character that it may affect the efficiency of the Facilities or any part thereof, the Employer may give to the Contractor a notice requiring that tests of the defective part of the Facilities shall be made by the Contractor immediately upon completion of such remedial work, whereupon the Contractor shall carry out such tests.</p> <p>If such part fails the tests, the Contractor shall carry out further repair, replacement or making good (as the case may be) until that part of the Facilities passes such tests. The tests shall be agreed upon by the Employer and the Contractor.</p>
		28.7	<p>If the Contractor fails to commence the work necessary to remedy such defect or any damage to the Facilities caused by such defect within a reasonable time (which shall in no event be considered to be less than fifteen (15) days), the Employer may, following notice to the Contractor, proceed to do such work, and the reasonable costs incurred by the Employer in connection therewith shall be paid to the Employer by the Contractor or may be deducted by the Employer from any monies due the Contractor or claimed under the Performance Security.</p>
		28.8	<p>If the Facilities or any part thereof cannot be used by reason of such defect and/or making good of such defect, the Defect</p>

			Liability Period of the Facilities or such part, as the case may be, shall be extended by a period equal to the period during which the Facilities or such part cannot be used by the Employer because of any of the aforesaid reasons.
		28.9	Except as provided in GCCs 28 and 34, the Contractor shall be under no liability whatsoever and howsoever arising, and whether under the Contract or at law, in respect of defects in the Facilities or any part thereof, the Goods, design or engineering or work executed that appear after Completion of the Facilities or any part thereof, except where such defects are the result of the gross negligence, fraud, criminal or willful action of the Contractor.
		28.10	In addition, the Contractor shall also provide an extended warranty for any such component of the Facilities and during the period of time as may be specified in the SCC. Such obligation shall be in addition to the defect liability specified under GCC 28.2.
29.	Functional Guarantees	29.1	The Contractor guarantees that during the Guarantee Test, the Facilities and all parts thereof shall attain the Functional Guarantees specified in the corresponding Appendix (Functional Guarantees) to the Agreement, subject to and upon the conditions therein specified.
		29.2	If, for reasons attributable to the Contractor, the minimum level of the Functional Guarantees specified in the corresponding Appendix (Functional Guarantees) to the Agreement are not met either in whole or in part, the Contractor shall at its cost and expense make such changes, modifications and/or additions to the Plant or any part thereof as may be necessary to meet at least the minimum level of such Guarantees. The Contractor shall notify the Employer upon completion of the necessary changes, modifications and/or additions, and shall request the Employer to repeat the Guarantee Test until the minimum level of the Guarantees has been met. If the Contractor eventually fails to meet the minimum level of Functional Guarantees, the Employer may consider termination of the Contract, pursuant to GCC 43.2.2.
		29.3	If, for reasons attributable to the Contractor, the Functional Guarantees specified in the corresponding Appendix (Functional Guarantees) to the Agreement are not attained either in whole or in part, but the minimum level of the Functional Guarantees specified in the said Appendix to the Agreement is met, the Contractor shall, at the Contractor's option, either (a) make such changes, modifications and/or additions to the Facilities or any part thereof that are necessary to

			<p>attain the Functional Guarantees at its cost and expense, and shall request the Employer to repeat the Guarantee Test or</p> <p>(b) pay liquidated damages to the Employer in respect of the failure to meet the Functional Guarantees in accordance with the provisions in the corresponding Appendix (Functional Guarantees) to the Agreement.</p>
		29.4	<p>The payment of liquidated damages under GCC 29.3, up to the limitation of liability specified in the SCC, shall completely satisfy the Contractor's guarantees under GCC 29.3, and the Contractor shall have no further liability whatsoever to the Employer in respect thereof. Upon the payment of such liquidated damages by the Contractor, the Project Manager shall issue the Operational Acceptance Certificate for the Facilities or any part thereof in respect of which the liquidated damages have been so paid.</p>
30.	Patent Indemnity	30.1	<p>The Contractor shall, subject to the Employer's compliance with GCC 30.2, indemnify and hold harmless the Employer and its employees and officers from and against any and all suits, actions or administrative proceedings, claims, demands, losses, damages, costs, and expenses of whatsoever nature, including attorney's fees and expenses, which the Employer may suffer as a result of any infringement or alleged infringement of any patent, utility model, registered design, trademark, copyright or other intellectual property right registered or otherwise existing at the date of the Contract by reason of: (a) the installation of the Facilities by the Contractor or the use of the Facilities in the United Republic of Tanzania; and (b) the sale of the products produced by the Facilities in United Republic of Tanzania.</p> <p>Such indemnity shall not cover any use of the Facilities or any part thereof other than for the purpose indicated by or to be reasonably inferred from the Contract, any infringement resulting from the use of the Facilities or any part thereof, or any products produced thereby in association or combination with any other equipment, plant or materials not supplied by the Contractor, pursuant to the Agreement.</p>
		30.2	<p>If any proceedings are brought or any claim is made against the Employer arising out of the matters referred to in GCC 30.1, the Employer shall promptly give the Contractor a notice thereof, and the Contractor may at its own expense and in the Employer's name conduct such proceedings or claim and any negotiations for the settlement of any such proceedings or claim.</p>

			<p>If the Contractor fails to notify the Employer within twenty-eight (28) days after receipt of such notice that it intends to conduct any such proceedings or claim, then the Employer shall be free to conduct the same on its own behalf. Unless the Contractor has so failed to notify the Employer within the twenty-eight (28) day period, the Employer shall make no admission that may be prejudicial to the defense of any such proceedings or claim.</p> <p>The Employer shall, at the Contractor's request, afford all available assistance to the Contractor in conducting such proceedings or claim, and shall be reimbursed by the Contractor for all reasonable expenses incurred in so doing.</p>
		30.3	<p>The Employer shall indemnify and hold harmless the Contractor and its employees, officers and Subcontractors from and against any and all suits, actions or administrative proceedings, claims, demands, losses, damages, costs, and expenses of whatsoever nature, including attorney's fees and expenses, which the Contractor may suffer as a result of any infringement or alleged infringement of any patent, utility model, registered design, trademark, copyright or other intellectual property right registered or otherwise existing at the date of the Contract arising out of or in connection with any design, data, drawing, specification, or other documents or materials provided or designed by or on behalf of the Employer.</p>
31.	Limitation of Liability	31.1	<p>Except in cases of criminal negligence or willful misconduct,</p> <p>(a) the Contractor shall not be liable to the Employer, whether in contract, tort, or otherwise, for any indirect or consequential loss or damage, loss of use, loss of production, or loss of profits or interest costs, provided that this exclusion shall not apply to any obligation of the Contractor to pay liquidated damages to the Employer and</p> <p>(b) the aggregate liability of the Contractor to the Employer, whether under the Contract, in tort or otherwise, shall not exceed the total Contract Price, provided that this limitation shall not apply to the cost of repairing or replacing defective equipment, or to any obligation of the Contractor to indemnify the Employer with respect to patent infringement.</p>

G. Risk Distribution

32.	Transfer of Ownership	32.1	Ownership of the Goods (including spare parts) to be imported into the United Republic of Tanzania shall be
-----	-----------------------	------	---

			transferred to the Employer upon loading on to the mode of transport to be used to convey the Goods from the country of origin.
		32.2	Ownership of the Goods (including spare parts) procured in the United Republic of Tanzania where the Site is located shall be transferred to the Employer when the Goods are brought on to the Site.
		32.3	Ownership of the Contractor's Equipment used by the Contractor and its Subcontractors in connection with the Contract shall remain with the Contractor or its Subcontractors.
		32.4	Ownership of any Goods in excess of the requirements for the Facilities shall revert to the Contractor upon Completion of the Facilities or at such earlier time when the Employer and the Contractor agree that the Goods in question are no longer required for the Facilities.
		32.5	Notwithstanding the transfer of ownership of the Goods, the responsibility for care and custody thereof together with the risk of loss or damage thereto shall remain with the Contractor pursuant to GCC 33 (Care of Facilities) hereof until Completion of the Facilities or the part thereof in which such Goods are incorporated.
33.	Care of Facilities	33.1	The Contractor shall be responsible for the care and custody of the Facilities or any part thereof until the date of Completion of the Facilities pursuant to GCC 25 or, where the Contract provides for Completion of the Facilities in parts, until the date of Completion of the relevant part, and shall make good at its own cost any loss or damage that may occur to the Facilities or the relevant part thereof from any cause whatsoever during such period. The Contractor shall also be responsible for any loss or damage to the Facilities caused by the Contractor or its Subcontractors in the course of any work carried out, pursuant to GCC 28. Notwithstanding the foregoing, the Contractor shall not be liable for any loss or damage to the Facilities or that part thereof caused by reason of any of the matters specified or referred to in paragraphs (a), (b) and (c) of GCCs 33.2 and 39.1.
		33.2	If any loss or damage occurs to the Facilities or any part thereof or to the Contractor's temporary facilities by reason of (a) (insofar as they relate to the United Republic of Tanzania, where the Site is located) nuclear reaction, nuclear radiation, radioactive contamination, pressure wave caused by aircraft or other aerial objects, or any

			<p>other occurrences that an experienced contractor could not reasonably foresee, or if reasonably foreseeable could not reasonably make provision for or insure against, insofar as such risks are not normally insurable on the insurance market and are mentioned in the general exclusions of the policy of insurance, including War Risks and Political Risks, taken out under GCC 35 hereof</p> <p>(b) any use or occupation by the Employer or any third party (other than a Subcontractor) authorized by the Employer of any part of the Facilities</p> <p>(c) any use of or reliance upon any design, data or specification provided or designated by or on behalf of the Employer, or any such matter for which the Contractor has disclaimed responsibility herein,</p> <p>the Employer shall pay to the Contractor all sums payable in respect of the Facilities executed, notwithstanding that the same be lost, destroyed or damaged, and will pay to the Contractor the replacement value of all temporary facilities and all parts thereof lost, destroyed or damaged. If the Employer requests the Contractor in writing to make good any loss or damage to the Facilities thereby occasioned, the Contractor shall make good the same at the cost of the Employer in accordance with GCC 40. If the Employer does not request the Contractor in writing to make good any loss or damage to the Facilities thereby occasioned, the Employer shall either request a change in accordance with GCC 40, excluding the performance of that part of the Facilities thereby lost, destroyed or damaged, or, where the loss or damage affects a substantial part of the Facilities, the Employer shall terminate the Contract pursuant to GCC 43.1 hereof.</p>
		33.3	<p>The Contractor shall be liable for any loss of or damage to any Contractor's Equipment, or any other property of the Contractor used or intended to be used for purposes of the Facilities, except (i) as mentioned in GCC 33.2 (with respect to the Contractor's temporary facilities), and (ii) where such loss or damage arises by reason of any of the matters specified in GCCs 33.2 (b) and (c) and 39.1.</p>
		33.4	<p>With respect to any loss or damage caused to the Facilities or any part thereof or to the Contractor's Equipment by reason of any of the matters specified in GCC 39.1, the provisions of GCC 39.3 shall apply.</p>

34.	Loss of or Damage to Property; Accident or Injury to Workers; Indemnification	34.1	Subject to GCC 33.3, the Contractor shall indemnify and hold harmless the Employer and its employees and officers from and against any and all suits, actions or administrative proceedings, claims, demands, losses, damages, costs, and expenses of whatsoever nature, including attorney's fees and expenses, in respect of the death or injury of any person or loss of or damage to any property (other than the Facilities whether accepted or not), arising in connection with the supply and installation of the Facilities and by reason of the negligence of the Contractor or its Subcontractors, or their employees, officers or agents, except any injury, death or property damage caused by the negligence of the Employer, its contractors, employees, officers or agents.
		34.2	<p>If any proceedings are brought or any claim is made against the Employer that might subject the Contractor to liability under GCC 34.1, the Employer shall promptly give the Contractor a notice thereof and the Contractor may at its own expense and in the Employer's name conduct such proceedings or claim and any negotiations for the settlement of any such proceedings or claim.</p> <p>If the Contractor fails to notify the Employer within twenty-eight (28) days after receipt of such notice that it intends to conduct any such proceedings or claim, then the Employer shall be free to conduct the same on its own behalf. Unless the Contractor has so failed to notify the Employer within the twenty-eight (28) day period, the Employer shall make no admission that may be prejudicial to the defense of any such proceedings or claim.</p> <p>The Employer shall, at the Contractor's request, afford all available assistance to the Contractor in conducting such proceedings or claim, and shall be reimbursed by the Contractor for all reasonable expenses incurred in so doing.</p>
		34.3	The Employer shall indemnify and hold harmless the Contractor and its employees, officers and Subcontractors from any liability for loss of or damage to property of the Employer, other than the Facilities not yet taken over, that is caused by fire, explosion or any other perils, in excess of the amount recoverable from insurances procured under GCC 35, provided that such fire, explosion or other perils were not caused by any act or failure of the Contractor.
		34.4	The party entitled to the benefit of an indemnity under this GCC 34 shall take all reasonable measures to mitigate any loss or damage which has occurred. If the party fails

			to take such measures, the other party's liabilities shall be correspondingly reduced.
35.	Insurance	35.1	<p>To the extent specified in the corresponding Appendix (Insurance Requirements) to the Agreement, the Contractor shall at its expense take out and maintain in effect, or cause to be taken out and maintained in effect, during the performance of the Contract, the insurances set forth below in the sums and with the deductibles and other conditions specified in the said Appendix. The identity of the insurers and the form of the policies shall be subject to the approval of the Employer, who should not unreasonably withhold such approval.</p> <p>(a) <u>Cargo Insurance During Transport</u></p> <p>Covering loss or damage occurring while in transit from the Contractor's or Subcontractor's works or stores until arrival at the Site, to the Goods (including spare parts therefore) and to the Contractor's Equipment.</p> <p>(b) <u>Installation All Risks Insurance</u></p> <p>Covering physical loss or damage to the Facilities at the Site, occurring prior to Completion of the Facilities, with an extended maintenance coverage for the Contractor's liability in respect of any loss or damage occurring during the Defect Liability Period while the Contractor is on the Site for the purpose of performing its obligations during the Defect Liability Period.</p> <p>(c) <u>Third Party Liability Insurance</u></p> <p>Covering bodily injury or death suffered by third parties (including the Employer's personnel) and loss of or damage to property occurring in connection with the supply and installation of the Facilities.</p> <p>(d) <u>Automobile Liability Insurance</u></p> <p>Covering use of all vehicles used by the Contractor or its Subcontractors (whether or not owned by them) in connection with the execution of the Contract.</p> <p>(e) <u>Workers' Compensation</u></p> <p>In accordance with the statutory requirements applicable in United Republic of Tanzania.</p> <p>(f) <u>Employer's Liability</u></p>

			<p>In accordance with the statutory requirements applicable in United Republic of Tanzania.</p> <p>(g) <u>Other Insurances</u></p> <p>Such other insurances as may be specifically agreed upon by the parties hereto as listed in the said the corresponding Appendix.</p>
		35.2	<p>The Employer shall be named as co-insured under all insurance policies taken out by the Contractor pursuant to GCC 35.1, except for the Third Party Liability, Workers' Compensation and Employer's Liability Insurances, and the Contractor's Subcontractors shall be named as co-insured's under all insurance policies taken out by the Contractor pursuant to GCC 35.1 except for the Cargo Insurance During Transport, Workers' Compensation and Employer's Liability Insurances. All insurer's rights of subrogation against such co-insured's for losses or claims arising out of the performance of the Contract shall be waived under such policies.</p>
		35.3	<p>The Contractor shall, in accordance with the provisions of the corresponding Appendix (Insurance Requirements) to the Agreement, deliver to the Employer certificates of insurance (or copies of the insurance policies) as evidence that the required policies are in full force and effect. The certificates shall provide that no less than twenty-one (21) days' notice shall be given to the Employer by insurers prior to cancellation or material modification of a policy.</p>
		35.4	<p>The Contractor shall ensure that, where applicable, its Subcontractor(s) shall take out and maintain in effect adequate insurance policies for their personnel and vehicles and for work executed by them under the Contract, unless such Subcontractors are covered by the policies taken out by the Contractor.</p>

		35.5	<p>The Employer shall at its expense take out and maintain in effect during the performance of the Contract those insurances specified in the corresponding Appendix (Insurance Requirements) to the Agreement, in the sums and with the deductibles and other conditions specified in the said Appendix. The Contractor and the Contractor's Subcontractors shall be named as co-insured's under all such policies. All insurers' rights of subrogation against such co-insured's for losses or claims arising out of the performance of the Contract shall be waived under such policies. The Employer shall deliver to the Contractor satisfactory evidence that the required insurances are in full force and effect. The policies shall provide that not less than twenty-one (21) days' notice shall be given to the Contractor by all insurers prior to any cancellation or material modification of the policies. If so requested by the Contractor, the Employer shall provide copies of the policies taken out by the Employer under this GCC 35.5.</p>
		35.6	<p>If the Contractor fails to take out and/or maintain in effect the insurances referred to in GCC 35.1, the Employer may take out and maintain in effect any such insurances and may from time to time deduct from any amount due the Contractor under the Contract any premium that the Employer shall have paid to the insurer, or may otherwise recover such amount as a debt due from the Contractor. If the Employer fails to take out and/or maintain in effect the insurances referred to in GCC 35.5, the Contractor may take out and maintain in effect any such insurances and may from time to time deduct from any amount due the Employer under the Contract any premium that the Contractor shall have paid to the insurer, or may otherwise recover such amount as a debt due from the Employer. If the Contractor fails to or is unable to take out and maintain in effect any such insurances, the Contractor shall nevertheless have no liability or responsibility towards the Employer, and the Contractor shall have full recourse against the Employer for any and all liabilities of the Employer herein.</p>
		35.7	<p>Unless otherwise provided in the Contract, the Contractor shall prepare and conduct all and any claims made under the policies effected by it pursuant to this GCC 35, and all monies payable by any insurers shall be paid to the Contractor. The Employer shall give to the Contractor all such reasonable assistance as may be required by the Contractor. With respect to insurance claims in which the Employer's interest is involved, the Contractor shall not give any release or make any compromise with the insurer without the prior written consent of the Employer. With respect to insurance claims in which the Contractor's</p>

			interest is involved, the Employer shall not give any release or make any compromise with the insurer without the prior written consent of the Contractor.
36.	Unforeseen Conditions	36.1	<p>If, during the execution of the Contract, the Contractor shall encounter on the Site any physical conditions (other than climatic conditions) or artificial obstructions that could not have been reasonably foreseen prior to the date of the Agreement by an experienced contractor on the basis of reasonable examination of the data relating to the Facilities (including any data as to boring tests) provided by the Employer, and on the basis of information that it could have obtained from a visual inspection of the Site (if access thereto was available) or other data readily available to it relating to the Facilities, and if the Contractor determines that it will in consequence of such conditions or obstructions incur additional cost and expense or require additional time to perform its obligations under the Contract that would not have been required if such physical conditions or artificial obstructions had not been encountered, the Contractor shall promptly, and before performing additional work or using additional Goods or Contractor's Equipment, notify the Project Manager in writing of</p> <ul style="list-style-type: none"> (a) the physical conditions or artificial obstructions on the Site that could not have been reasonably foreseen (b) the additional work and/or Goods and/or Contractor's Equipment required, including the steps which the Contractor will or proposes to take to overcome such conditions or obstructions (c) the extent of the anticipated delay (d) the additional cost and expense that the Contractor is likely to incur. <p>On receiving any notice from the Contractor under this GCC 36.1, the Project Manager shall promptly consult with the Employer and Contractor and decide upon the actions to be taken to overcome the physical conditions or artificial obstructions encountered. Following such consultations, the Project Manager shall instruct the Contractor, with a copy to the Employer, of the actions to be taken.</p>
		36.2	Any reasonable additional cost and expense incurred by the Contractor in following the instructions from the Project Manager to overcome such physical conditions or artificial obstructions referred to in GCC 36.1 shall be paid by the

			Employer to the Contractor as an addition to the Contract Price.
		36.3	If the Contractor is delayed or impeded in the performance of the Contract because of any such physical conditions or artificial obstructions referred to in GCC 36.1, the Time for Completion shall be extended in accordance with GCC 41.
37.	Change in Laws and Regulations	37.1	If, after the date twenty-eight (28) days prior to the date of Tender submission, in the United Republic of Tanzania, any law, regulation, ordinance, order or by-law having the force of law is enacted, promulgated, abrogated or changed (which shall be deemed to include any change in interpretation or application by the competent authorities) that subsequently affects the costs and expenses of the Contractor and/or the Time for Completion, the Contract Price shall be correspondingly increased or decreased, and/or the Time for Completion shall be reasonably adjusted to the extent that the Contractor has thereby been affected in the performance of any of its obligations under the Contract. Notwithstanding the foregoing, such additional or reduced costs shall not be separately paid or credited if the same has already been accounted for in the price adjustment provisions where applicable, in accordance with the SCC.
38.	Force Majeure	38.1	Force majeure shall include, without limitation, the following: <ul style="list-style-type: none"> (a) war, hostilities or warlike operations (whether a state of war be declared or not), invasion, act of foreign enemy and civil war (b) rebellion, revolution, insurrection, mutiny, usurpation of civil or military government, conspiracy, riot, civil commotion and terrorist acts (c) confiscation, nationalization, mobilization, commandeering or requisition by or under the order of any government or de jure or de facto authority or ruler or any other act or failure to act of any local state or national government authority (d) strike, sabotage, lockout, embargo, import restriction, port congestion, lack of usual means of public transportation and communication, industrial dispute, shipwreck, shortage or restriction of power supply, epidemics, quarantine and plague (e) earthquake, landslide, volcanic activity, fire, flood or inundation, tidal wave, typhoon or cyclone, hurricane,

			<p>storm, lightning, or other inclement weather condition, nuclear and pressure waves or other natural or physical disaster</p> <p>(f) shortage of labour, materials or utilities where caused by circumstances that are themselves Force Majeure.</p>
		38.2	<p>If either party is prevented, hindered or delayed from or in performing any of its obligations under the Contract by an event of Force Majeure, then it shall notify the other in writing of the occurrence of such event and the circumstances thereof within fourteen (14) days after the occurrence of such event.</p>
		38.3	<p>The party who has given such notice shall be excused from the performance or punctual performance of its obligations under the Contract for so long as the relevant event of Force Majeure continues and to the extent that such party's performance is prevented, hindered or delayed. The Time for Completion shall be extended in accordance with GCC 41.</p>
		38.4	<p>The party or parties affected by the event of Force Majeure shall use reasonable efforts to mitigate the effect thereof upon its or their performance of the Contract and to fulfill its or their obligations under the Contract, but without prejudice to either party's right to terminate the Contract under GCCs 38.6 and 39.5.</p>
		38.5	<p>No delay or nonperformance by either party hereto caused by the occurrence of any event of Force Majeure shall</p> <p>(a) constitute a default or breach of the Contract</p> <p>(b) (subject to GCCs 33.2, 39.3 and 39.4) give rise to any claim for damages or additional cost or expense occasioned thereby</p> <p>if and to the extent that such delay or nonperformance is caused by the occurrence of an event of Force Majeure.</p>
		38.6	<p>If the performance of the Contract is substantially prevented, hindered or delayed for a single period of more than sixty (60) days or an aggregate period of more than one hundred and twenty (120) days on account of one or more events of Force Majeure during the currency of the Contract, the parties will attempt to develop a mutually satisfactory solution, failing which either party may terminate the Contract by giving a notice to the other, but without prejudice to either party's right to terminate the Contract under GCC 39.5.</p>

		38.7	In the event of termination pursuant to GCC 38.6, the rights and obligations of the Employer and the Contractor shall be as specified in GCCs 43.1.2 and 43.1.3.
		38.8	Notwithstanding GCC 38.5, Force Majeure shall not apply to any obligation of the Employer to make payments to the Contractor herein.
39.	War Risks	39.1	"War Risks" shall mean any event specified in paragraphs (a) and (b) of GCC 38.1 and any explosion or impact of any mine, bomb, shell, grenade or other projectile, missile, munitions or explosive of war, occurring or existing in or near the United Republic of Tanzania where the Site is located.
		39.2	<p>Notwithstanding anything contained in the Contract, the Contractor shall have no liability whatsoever for or with respect to</p> <ul style="list-style-type: none"> (a) destruction of or damage to Facilities, Goods, or any part thereof (b) destruction of or damage to property of the Employer or any third party (c) injury or loss of life <p>if such destruction, damage, injury or loss of life is caused by any War Risks, and the Employer shall indemnify and hold the Contractor harmless from and against any and all claims, liabilities, actions, lawsuits, damages, costs, charges or expenses arising in consequence of or in connection with the same.</p>
		39.3	<p>If the Facilities or any Goods or Contractor's Equipment or any other property of the Contractor used or intended to be used for the purposes of the Facilities shall sustain destruction or damage by reason of any War Risks, the Employer shall pay the Contractor for</p> <ul style="list-style-type: none"> (a) any part of the Facilities or the Goods so destroyed or damaged (to the extent not already paid for by the Employer) (b) replacing or making good any Contractor's Equipment or other property of the Contractor so destroyed or damaged (c) replacing or making good any such destruction or damage to the Facilities or the Goods or any part thereof so far as may be required by the Employer.

			<p>and as may be necessary for completion of the Facilities.</p> <p>If the Employer does not require the Contractor to replace or make good any such destruction or damage to the Facilities, the Employer shall either request a change in accordance with GCC 40, excluding the performance of that part of the Facilities thereby destroyed or damaged or, where the loss, destruction or damage affects a substantial part of the Facilities, shall terminate the Contract, pursuant to GCC 43.1.</p>
		39.4	<p>Notwithstanding anything contained in the Contract, the Employer shall pay the Contractor for any increased costs or incidentals to the execution of the Contract that are in any way attributable to, consequent on, resulting from, or in any way connected with any War Risks, provided that the Contractor shall as soon as practicable notify the Employer in writing of any such increased cost.</p>
		39.5	<p>If during the performance of the Contract any War Risks shall occur that financially or otherwise materially affect the execution of the Contract by the Contractor, the Contractor shall use its reasonable efforts to execute the Contract with due and proper consideration given to the safety of its and its Subcontractors' personnel engaged in the work on the Facilities, provided, however, that if the execution of the work on the Facilities becomes impossible or is substantially prevented for a single period of more than sixty (60) days or an aggregate period of more than one hundred and twenty (120) days on account of any War Risks, the parties will attempt to develop a mutually satisfactory solution, failing which either party may terminate the Contract by giving a notice to the other.</p>
		39.6	<p>In the event of termination pursuant to GCCs 39.3 or 39.5, the rights and obligations of the Employer and the Contractor shall be specified in GCCs 43.1.2 and 43.1.3.</p>

H. Change in Contract Elements

40.	Change in the Facilities	40.1	<p><u>Introducing a Change</u></p> <p>40.1.1 Subject to GCCs 40.2.5 and 40.2.7, the Employer shall have the right to propose, and subsequently require, that the Project Manager order the Contractor from time to time during the performance of the Contract to make any change, modification, addition or deletion to, in or from the Facilities (hereinafter called "Change"), provided that such</p>
-----	--------------------------	------	---

		<p>Change falls within the general scope of the Facilities and does not constitute unrelated work and that it is technically practicable, taking into account both the state of advancement of the Facilities and the technical compatibility of the Change envisaged with the nature of the Facilities as specified in the Contract.</p> <p>40.1.2 The Contractor may from time to time during its performance of the Contract propose to the Employer (with a copy to the Project Manager) any Change that the Contractor considers necessary or desirable to improve the quality, efficiency or safety of the Facilities. The Employer may at its discretion approve or reject any Change proposed by the Contractor, provided that the Employer shall approve any Change proposed by the Contractor to ensure the safety of the Facilities.</p> <p>40.1.3 Notwithstanding GCCs 40.1.1 and 40.1.2, no change made necessary because of any default of the Contractor in the performance of its obligations under the Contract shall be deemed to be a Change, and such change shall not result in any adjustment of the Contract Price or the Time for Completion.</p> <p>40.1.4 The procedure on how to proceed with and execute Changes is specified in GCCs 40.2 and 40.3, and further details and sample forms are provided in the Sample Forms and Procedures section in the Tendering Documents.</p>
		<p>40.2 <u>Changes Originating from Employer</u></p> <p>39.2.1 If the Employer proposes a Change pursuant to GCC 40.1.1, it shall send to the Contractor a "Request for Change Proposal," requiring the Contractor to prepare and furnish to the Project Manager as soon as reasonably practicable a "Change Proposal," which shall include the following:</p> <ul style="list-style-type: none"> (a) brief description of the Change (b) effect on the Time for Completion (c) estimated cost of the Change (d) effect on Functional Guarantees (if any) (e) effect on any other provisions of the Contract.

		<p>39.2.2 Prior to preparing and submitting the "Change Proposal," the Contractor shall submit to the Project Manager an "Estimate for Change Proposal," which shall be an estimate of the cost of preparing and submitting the Change Proposal.</p> <p>Upon receipt of the Contractor's Estimate for Change Proposal, the Employer shall do one of the following:</p> <ul style="list-style-type: none"> (a) accept the Contractor's estimate with instructions to the Contractor to proceed with the preparation of the Change Proposal (b) advise the Contractor of any part of its Estimate for Change Proposal that is unacceptable and request the Contractor to review its estimate (c) advise the Contractor that the Employer does not intend to proceed with the Change. <p>40.2.3 Upon receipt of the Employer's instruction to proceed under GCC 40.2.2 (a), the Contractor shall, with proper expedition, proceed with the preparation of the Change Proposal, in accordance with GCC 40.2.1.</p> <p>40.2.4 The pricing of any Change shall, as far as practicable, be calculated in accordance with the rates and prices included in the Contract. If such rates and prices are inequitable, the parties thereto shall agree on specific rates for the valuation of the Change.</p> <p>40.2.5 If before or during the preparation of the Change Proposal it becomes apparent that the aggregate effect of compliance therewith and with all other Change Orders that have already become binding upon the Contractor under this GCC 40 would be to increase or decrease the Contract Price as originally set forth in Article 2 (Contract Price) of the Agreement by more than fifteen percent (15%), the Contractor may give a written notice of objection thereto prior to furnishing the Change Proposal as aforesaid. If the Employer accepts the Contractor's objection, the Employer shall withdraw the proposed Change and shall notify the Contractor in writing thereof.</p> <p>The Contractor's failure to so object shall neither affect its right to object to any subsequent requested Changes or Change Orders herein, nor affect its right to take into account, when making such</p>
--	--	---

		<p>subsequent objection, the percentage increase or decrease in the Contract Price that any Change not objected to by the Contractor represents.</p> <p>40.2.6 Upon receipt of the Change Proposal, the Employer and the Contractor shall mutually agree upon all matters therein contained. Within fourteen (14) days after such agreement, the Employer shall, if it intends to proceed with the Change, issue the Contractor with a Change Order.</p> <p>If the Employer is unable to reach a decision within fourteen (14) days, it shall notify the Contractor with details of when the Contractor can expect a decision.</p> <p>If the Employer decides not to proceed with the Change for whatever reason, it shall, within the said period of fourteen (14) days, notify the Contractor accordingly. Under such circumstances, the Contractor shall be entitled to reimbursement of all costs reasonably incurred by it in the preparation of the Change Proposal, provided that these do not exceed the amount given by the Contractor in its Estimate for Change Proposal submitted in accordance with GCC 40.2.2.</p> <p>40.2.7 If the Employer and the Contractor cannot reach agreement on the price for the Change, an equitable adjustment to the Time for Completion, or any other matters identified in the Change Proposal, the Employer may nevertheless instruct the Contractor to proceed with the Change by issue of a "Pending Agreement Change Order."</p> <p>Upon receipt of a Pending Agreement Change Order, the Contractor shall immediately proceed with effecting the Changes covered by such Order. The parties shall thereafter attempt to reach agreement on the outstanding issues under the Change Proposal.</p> <p>If the parties cannot reach agreement within sixty (60) days from the date of issue of the Pending Agreement Change Order, then the matter may be referred to the Adjudicator in accordance with the provisions of GCC 6.1.</p>
		<p>40.3 <u>Changes Originating from Contractor</u></p> <p>40.3.1 If the Contractor proposes a Change pursuant to GCC 40.1.2, the Contractor shall submit to the</p>

			<p>Project Manager a written "Application for Change Proposal," giving reasons for the proposed Change and including the information specified in GCC 40.2.1.</p> <p>40.3.2 Upon receipt of the Application for Change Proposal, the parties shall follow the procedures outlined in GCCs 40.2.6 and 40.2.7. However, should the Employer choose not to proceed, the Contractor shall not be entitled to recover the costs of preparing the Application for Change Proposal.</p>
41.	Extension of Time for Completion	41.1	<p>The Time(s) for Completion specified in the SCC shall be extended if the Contractor is delayed or impeded in the performance of any of its obligations under the Contract by reason of any of the following:</p> <ul style="list-style-type: none"> (a) any Change in the Facilities as provided in GCC 40 (b) any occurrence of Force Majeure as provided in GCC 38, unforeseen conditions as provided in GCC 36, or other occurrence of any of the matters specified or referred to in paragraphs (a), (b) and (c) of GCC 33.2 (c) any suspension order given by the Employer under GCC 42 hereof or reduction in the rate of progress pursuant to GCC 42.2 or (d) any changes in laws and regulations as provided in GCC 37 or (e) any default or breach of the Contract by the Employer, specifically including failure to supply the items listed in the corresponding Appendix (Scope of Works and Supply by the Employer) to the Agreement, or any activity, act or omission of any other contractors employed by the Employer or (f) any other matter specifically mentioned in the Contract by such period as shall be fair and reasonable in all the circumstances and as shall fairly reflect the delay or impediment sustained by the Contractor.
		41.2	<p>Except where otherwise specifically provided in the Contract, the Contractor shall submit to the Project Manager a notice of a claim for an extension of the Time for Completion, together with particulars of the event or circumstance justifying such extension as soon as reasonably practicable after the commencement of such event or circumstance. As soon as reasonably practicable after receipt of such notice and supporting particulars of the claim, the Employer and the Contractor shall agree upon the period of such extension. In the event that the Contractor does not accept</p>

John

			the Employer's estimate of a fair and reasonable time extension, the Contractor shall be entitled to refer the matter to an Adjudicator, pursuant to GCC 6.1.
		41.3	The Contractor shall at all times use its reasonable efforts to minimize any delay in the performance of its obligations under the Contract.
42.	Suspension	42.1	<p>The Employer may request the Project Manager, by notice to the Contractor, to order the Contractor to suspend performance of any or all of its obligations under the Contract. Such notice shall specify the obligation of which performance is to be suspended, the effective date of the suspension and the reasons thereof. The Contractor shall thereupon suspend performance of such obligation (except those obligations necessary for the care or preservation of the Facilities) until ordered in writing to resume such performance by the Project Manager.</p> <p>If, by virtue of a suspension order given by the Project Manager, other than by reason of the Contractor's default or breach of the Contract, the Contractor's performance of any of its obligations is suspended for an aggregate period of more than ninety (90) days, then at any time thereafter and provided that at that time such performance is still suspended, the Contractor may give a notice to the Project Manager requiring that the Employer shall, within twenty-eight (28) days of receipt of the notice, order the resumption of such performance or request and subsequently order a change in accordance with GCC 40, excluding the performance of the suspended obligations from the Contract.</p> <p>If the Employer fails to do so within such period, the Contractor may, by a further notice to the Project Manager, elect to treat the suspension, where it affects a part only of the Facilities, as a deletion of such part in accordance with GCC 40 or, where it affects the whole of the Facilities, as termination of the Contract under GCC 43.1.</p>
		42.2	<p>If:</p> <p>(a) the Employer has failed to pay the Contractor any sum due under the Contract within the specified period, has failed to approve any invoice or supporting documents without just cause pursuant to the corresponding Appendix (Terms and Procedures of Payment) to the Agreement, or commits a substantial breach of the Contract, the Contractor may give a notice to the Employer that requires payment of such sum, with interest thereon as stipulated in GCC 13.3, requires approval of such invoice or supporting documents, or specifies the breach and requires the Employer to</p>

			<p>remedy the same, as the case may be. If the Employer fails to pay such sum together with such interest, fails to approve such invoice or supporting documents or give its reasons for withholding such approval, or fails to remedy the breach or take steps to remedy the breach within fourteen (14) days after receipt of the Contractor's notice or</p> <p>(b) the Contractor is unable to carry out any of its obligations under the Contract for any reason attributable to the Employer, including but not limited to the Employer's failure to provide possession of or access to the Site or other areas in accordance with GCC 11.2, or failure to obtain any governmental permit necessary for the execution and/or completion of the Facilities,</p> <p>then the Contractor may by fourteen (14) days' notice to the Employer suspend performance of all or any of its obligations under the Contract, or reduce the rate of progress.</p>
		42.3	<p>If the Contractor's performance of its obligations is suspended or the rate of progress is reduced pursuant to this GCC 42, then the Time for Completion shall be extended in accordance with GCC 41.1, and any and all additional costs or expenses incurred by the Contractor as a result of such suspension or reduction shall be paid by the Employer to the Contractor in addition to the Contract Price, except in the case of suspension order or reduction in the rate of progress by reason of the Contractor's default or breach of the Contract.</p>
		42.4	<p>During the period of suspension, the Contractor shall not remove from the Site any Goods, any part of the Facilities or any Contractor's Equipment, without the prior written consent of the Employer.</p>
43.	Termination	43.1	<p><u>Termination for Employer's Convenience</u></p> <p>434.1.1 The Employer may at any time terminate the Contract for any reason by giving the Contractor a notice of termination that refers to this GCC 43.1.</p> <p>43.1.2 Upon receipt of the notice of termination under GCC 43.1.1, the Contractor shall either immediately or upon the date specified in the notice of termination</p> <p>(a) cease all further work, except for such work as the Employer may specify in the notice of termination for the sole purpose of protecting that part of the Facilities already executed, or</p>

any work required to leave the Site in a clean and safe condition

- (b) terminate all subcontracts, except those to be assigned to the Employer pursuant to paragraph (d) (ii) below
- (c) remove all Contractor's Equipment from the Site, repatriate the Contractor's and its Subcontractors' personnel from the Site, remove from the Site any wreckage, rubbish and debris of any kind, and leave the whole of the Site in a clean and safe condition
- (d) In addition, the Contractor, subject to the payment specified in GCC 43.1.3, shall
 - (i) deliver to the Employer the parts of the Facilities executed by the Contractor up to the date of termination
 - (ii) to the extent legally possible, assign to the Employer all right, title and benefit of the Contractor to the Facilities and to the Goods as of the date of termination, and, as may be required by the Employer, in any subcontracts concluded between the Contractor and its Subcontractors
 - (iii) deliver to the Employer all non-proprietary drawings, specifications and other documents prepared by the Contractor or its Subcontractors as at the date of termination in connection with the Facilities.

43.1.3 In the event of termination of the Contract under GCC 43.1.1, the Employer shall pay to the Contractor the following amounts:

- (a) the Contract Price, properly attributable to the parts of the Facilities executed by the Contractor as of the date of termination
- (b) the costs reasonably incurred by the Contractor in the removal of the Contractor's Equipment from the Site and in the repatriation of the Contractor's and its Subcontractors' personnel
- (c) any amounts to be paid by the Contractor to its Subcontractors in connection with the termination of any subcontracts, including any cancellation charges

			<p>(d) costs incurred by the Contractor in protecting the Facilities and leaving the Site in a clean and safe condition pursuant to paragraph (a) of GCC 43.1.2</p> <p>(e) the cost of satisfying all other obligations, commitments and claims that the Contractor may in good faith have undertaken with third parties in connection with the Contract and that are not covered by paragraphs (a) through (d) above.</p>
		43.2	<p><u>Termination for Contractor's Default</u></p> <p>43.2.1 The Employer, without prejudice to any other rights or remedies it may possess, may terminate the Contract forthwith in the following circumstances by giving a notice of termination and its reasons thereof to the Contractor, referring to this GCC 43.2:</p> <p>(a) If the Contractor becomes bankrupt or insolvent, has a receiving order issued against it, compounds with its creditors, or, if the Contractor is a corporation, a resolution is passed or order is made for its winding up (other than a voluntary liquidation for the purposes of amalgamation or reconstruction), a receiver is appointed over any part of its undertaking or assets, or if the Contractor takes or suffers any other analogous action in consequence of debt</p> <p>(b) if the Contractor assigns or transfers the Contract or any right or interest therein in violation of the provision of GCC 44.</p> <p>(c) if the Contractor, in the judgment of the Employer has engaged in corrupt, coercive, collusive, obstructive or fraudulent practices in competing for or in executing the Contract.</p> <p>For the purpose of this paragraph:</p> <p>i. "corrupt practice means the offering, giving receiving or soliciting of anything of value to influence the action of a public officer in the procurement process or contract execution;</p> <p>ii. "coercive practice" means impairing or harming, or threatening to impair or harm directly or indirectly, any party or the property of the party for the purpose of influencing improperly the action or that party in</p>

connection with public procurement or in furtherance of corrupt practice or fraudulent practice;

- iii. "collusive practices" means impairing or harming, or threatening to impair or harm directly or indirectly, any part or the property of the Party for the purpose of influencing improperly the action or a part or in connection with public procurement or government contracting or in furtherance of a corrupt practice or a Fraudulent Practice
- iv. "fraudulent practice" means a misrepresentation of facts in order to influence a procurement process or the execution of a contract to the detriment of the Government or a public body and includes collusive practices among tenderers, prior to or after submission designed to establish tender prices at artificial non-competitive levels and to deprive the Government of the benefits of free and open competition;
- v. "obstructive practice" means acts intended to materially impede access to required information in exercising a duty under this Act;

43.2.2 If the Contractor

- (a) has abandoned or repudiated the Contract
- (b) has without valid reason failed to commence work on the Facilities promptly or has suspended (other than pursuant to GCC 42.2) the progress of Contract performance for more than twenty-eight (28) days after receiving a written instruction from the Employer to proceed
- (c) persistently fails to execute the Contract in accordance with the Contract or persistently neglects to carry out its obligations under the Contract without just cause
- (d) refuses or is unable to provide sufficient materials, services or labour to execute and complete the Facilities in the manner specified in the programme furnished under GCC 19.2 at rates of progress that give reasonable assurance to the Employer that the Contractor can attain Completion of the Facilities by the Time for

Completion as extended, then the Employer may, without prejudice to any other rights it may possess under the Contract, give a notice to the Contractor stating the nature of the default and requiring the Contractor to remedy the same. If the Contractor fails to remedy or to take steps to remedy the same within fourteen (14) days of its receipt of such notice, then the Employer may terminate the Contract forthwith by giving a notice of termination to the Contractor that refers to this GCC 43.2.

43.2.3 Upon receipt of the notice of termination under GCCs 43.2.1 or 43.2.2, the Contractor shall, either immediately or upon such date as is specified in the notice of termination,

- (a) cease all further work, except for such work as the Employer may specify in the notice of termination for the sole purpose of protecting that part of the Facilities already executed, or any work required to leave the Site in a clean and safe condition
- (b) terminate all subcontracts, except those to be assigned to the Employer pursuant to paragraph (d) below
- (c) deliver to the Employer the parts of the Facilities executed by the Contractor up to the date of termination
- (d) to the extent legally possible, assign to the Employer all right, title and benefit of the Contractor to the Facilities and to the Goods as of the date of termination, and, as may be required by the Employer, in any subcontracts concluded between the Contractor and its Subcontractors
- (e) deliver to the Employer all drawings, specifications and other documents prepared by the Contractor or its Subcontractors as of the date of termination in connection with the Facilities.

43.2.4 The Employer may enter upon the Site, expel the Contractor, and complete the Facilities itself or by employing any third party. The Employer may, to the exclusion of any right of the Contractor over the same, take over and use with the payment of a fair rental rate to the Contractor, with all the

maintenance costs to the account of the Employer and with an indemnification by the Employer for all liability including damage or injury to persons arising out of the Employer's use of such equipment, any Contractor's Equipment owned by the Contractor and on the Site in connection with the Facilities for such reasonable period as the Employer considers expedient for the supply and installation of the Facilities.

Upon completion of the Facilities or at such earlier date as the Employer thinks appropriate, the Employer shall give notice to the Contractor that such Contractor's Equipment will be returned to the Contractor at or near the Site and shall return such Contractor's Equipment to the Contractor in accordance with such notice. The Contractor shall thereafter without delay and at its cost remove or arrange removal of the same from the Site.

43.2.5 Subject to GCC 43.2.6, the Contractor shall be entitled to be paid the Contract Price attributable to the Facilities executed as of the date of termination, the value of any unused or partially used Goods on the Site, and the costs, if any, incurred in protecting the Facilities and in leaving the Site in a clean and safe condition pursuant to paragraph (a) of GCC 43.2.3. Any sums due the Employer from the Contractor accruing prior to the date of termination shall be deducted from the amount to be paid to the Contractor under this Contract.

43.2.6 If the Employer completes the Facilities, the cost of completing the Facilities by the Employer shall be determined.

If the sum that the Contractor is entitled to be paid, pursuant to GCC 43.2.5, plus the reasonable costs incurred by the Employer in completing the Facilities, exceeds the Contract Price, the Contractor shall be liable for such excess.

If such excess is greater than the sums due the Contractor under GCC 43.2.5, the Contractor shall pay the balance to the Employer, and if such excess is less than the sums due the Contractor under GCC 43.2.5, the Employer shall pay the balance to the Contractor.

The Employer and the Contractor shall agree, in writing, on the computation described above and the manner in which any sums shall be paid.

43.3 Termination by Contractor

43.3.1 If

(a) the Employer has failed to pay the Contractor any sum due under the Contract within the specified period, has failed to approve any invoice or supporting documents without just cause pursuant to the corresponding Appendix (Terms and Procedures of Payment) of the Agreement, or commits a substantial breach of the Contract, the Contractor may give a notice to the Employer that requires payment of such sum, with interest thereon as stipulated in GCC 13.3, requires approval of such invoice or supporting documents, or specifies the breach and requires the Employer to remedy the same, as the case may be. If the Employer fails to pay such sum together with such interest, fails to approve such invoice or supporting documents or give its reasons for withholding such approval, fails to remedy the breach or take steps to remedy the breach within fourteen (14) days after receipt of the Contractor's notice, or

(b) the Contractor is unable to carry out any of its obligations under the Contract for any reason attributable to the Employer, including but not limited to the Employer's failure to provide possession of or access to the Site or other areas or failure to obtain any governmental permit necessary for the execution and/or completion of the Facilities,

then the Contractor may give a notice to the Employer thereof, and if the Employer has failed to pay the outstanding sum, to approve the invoice or supporting documents, to give its reasons for withholding such approval, or to remedy the breach within twenty-eight (28) days of such notice, or if the Contractor is still unable to carry out any of its obligations under the Contract for any reason attributable to the Employer within twenty-eight (28) days of the said notice, the Contractor may by a further notice to the Employer referring to this GCC 43.3.1, forthwith terminate the Contract.

43.3.2 The Contractor may terminate the Contract forthwith by giving a notice to the Employer to that effect, referring to this GCC 43.3.2, if the Employer becomes bankrupt or insolvent, has a receiving

order issued against it, compounds with its creditors, or, being a corporation, if a resolution is passed or order is made for its winding up (other than a voluntary liquidation for the purposes of amalgamation or reconstruction), a receiver is appointed over any part of its undertaking or assets, or if the Employer takes or suffers any other analogous action in consequence of debt.

43.3.3 If the Contract is terminated under GCCs 43.3.1 or 43.3.2, then the Contractor shall immediately

- (a) cease all further work, except for such work as may be necessary for the purpose of protecting that part of the Facilities already executed, or any work required to leave the Site in a clean and safe condition
- (b) terminate all subcontracts, except those to be assigned to the Employer pursuant to paragraph (d) (ii)
- (c) remove all Contractor's Equipment from the Site and repatriate the Contractor's and its Subcontractors' personnel from the Site.
- (d) In addition, the Contractor, subject to the payment specified in GCC 43.3.4, shall
 - (i) deliver to the Employer the parts of the Facilities executed by the Contractor up to the date of termination
 - (ii) to the extent legally possible, assign to the Employer all right, title and benefit of the Contractor to the Facilities and to the Goods as of the date of termination, and, as may be required by the Employer, in any subcontracts concluded between the Contractor and its Subcontractors
 - (iii) deliver to the Employer all drawings, specifications and other documents prepared by the Contractor or its Subcontractors as of the date of termination in connection with the Facilities.

43.3.4 If the Contract is terminated under GCCs 43.3.1 or 43.3.2, the Employer shall pay to the Contractor all payments specified in GCC 43.1.3, and reasonable compensation for all loss, except for loss of profit, or damage sustained by the Contractor arising out of,

			<p>in connection with or in consequence of such termination.</p> <p>43.3.5 Termination by the Contractor pursuant to this GCC 43.3 is without prejudice to any other rights or remedies of the Contractor that may be exercised in lieu of or in addition to rights conferred by GCC 43.3.</p>
		43.4	<p>In this GCC 43, the expression "Facilities executed" shall include all work executed, Installation Services provided, and all Goods acquired (or subject to a legally binding obligation to purchase) by the Contractor and used or intended to be used for the purpose of the Facilities, up to and including the date of termination.</p>
		43.5	<p>In this GCC 43, in calculating any monies due from the Employer to the Contractor, account shall be taken of any sum previously paid by the Employer to the Contractor under the Contract, including any advance payment paid pursuant to the corresponding Appendix (Terms and Procedures of Payment) to the Agreement.</p>
44.	Assignment	44.1	<p>Neither the Employer nor the Contractor shall, without the express prior written consent of the other party (which consent shall not be unreasonably withheld), assign to any third party the Contract or any part thereof, or any right, benefit, obligation or interest therein or thereunder, except that the Contractor shall be entitled to assign either absolutely or by way of charge any monies due and payable to it or that may become due and payable to it under the Contract.</p>

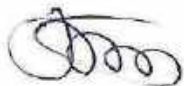

SECTION E: SCHEDULE OF REQUIREMENTS





FORMS OF TENDER AND PRICE SCHEDULES

Form of Tender

Date: 06th December, 2021
IFB N^o: PA-010/2021-2022/G/37

Supply, Installation and Commissioning of Digital X Ray for Mtwara Zonal and Morogoro RHH

To:

**Executive Director,
Ocean Road Cancer Institute – ORCI,
P. O. Box 3592,
DAR ES SALAAM TANZANIA.**

Ladies and/or Gentlemen,

Having examined the Tendering documents, including Addendum Nos. *NIL*, the receipt of which is hereby acknowledged, we, the undersigned, offer to design, manufacture, test, deliver, install, pre-commission and commission the Facilities under the above-named Contract in full conformity with the said Tendering documents for the sum of: **TZS: 1,282,000,000.00 (Tanzania Shillings: One Billion Two Hundred Eighty Two Million and Zero Cent Only)** or such other sums as may be determined in accordance with the terms and conditions of the Contract. The above amounts are in accordance with the Price Schedules attached herewith and are made part of this Tender.

We undertake, if our Tender is accepted, to commence the supply and installation of Facilities and to achieve Completion within the respective times stated in the Tendering documents.

If our Tender is accepted, we undertake to provide an advance payment security and a performance security in the form, in the amounts, and within the times specified in the Tendering documents.

We declare that our tendering price did not involve agreements with other Tenderer for the purpose of tender suppression.

We are not participating, as Tenderer, in more than one Tender in this tendering process other than alternative tenders in accordance with the tendering documents.

A handwritten signature in black ink, appearing to be 'J. J. J.', located at the bottom of the page.

KAS MEDICS LIMITED

Your partner in progressive healthcare



We hereby confirm **Tanzania Institute Arbitration**, to be the Appointing Authority, to appoint the adjudicator in case of any arisen disputes in accordance with ITT 45.1

We agree to abide by this Tender, for a period of **180 days** from the date fixed for submission of Tenders as stipulated in the Tendering documents, and it shall remain binding upon us and may be accepted by you at any time before the expiration of that period.

We declare that, as tenderer(s) we do not have conflict of interest with reference to ITT clause 3.7

Commissions or gratuities, if any, paid or to be paid by us to agents relating to this Tender, and to contract execution if we are awarded the contract, are listed below

Name and address of Agent	Amount and Currency	Purpose of Commission or Gratuity
.....NONE.....NONE..... NONE

Until a formal contract is prepared and signed between us, this Tender, together with your written acceptance thereof and your notification of award, shall constitute a binding contract between us.

We understand that you are not bound to accept the lowest or any Tender you may receive.

Dated this 06th day of December, 2021

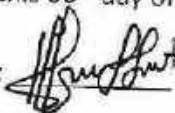
Signed:  **KAS MEDICS LTD.**
P. O. Box 7856
Name: **Charles Lintu** **DAR-ES-SALAAM**
TANZANIA

In the capacity of **Sales Administrative Executive**

Duly authorized to sign the tender for and on behalf of: **KAS MEDICS LTD**

KAS MEDICS LIMITED

Your Partner in Progressive Healthcare



EXECUTIVE DIRECTOR
OCEAN ROAD CANCER INSTITUTE HOSPITAL
P. O. BOX 3592
DAR ES SALAAM.

IFT No.: PA-010/2021-2022/G/37
Date: 05th December, 2021

SUPPLY, INSTALLATION AND COMMISSIONING OF DIGITAL X RAY FOR MTWARA ZONAL AND MOROGORO RHH

No	CODE	DESCRIPTION	QTY	UNIT PRICE	TOTAL PRICE TZS
1	FMT	DEL MEDICAL FLOOR MOUNTED DIGITAL RADIOGRAPHIC X-RAY SYSTEM.	3	290,000,000.00	870,000,000.00
	DM-FMT	<p>MANUFACTURER: DEL MEDICAL - USA</p> <p>Del Medical Floor Mounted Tube Stand</p> <p>Item Features:</p> <ul style="list-style-type: none"> - Platform Tube Mount - Telescopic vertical column with Tube support and operator controls - 10 ft. (305 cm) longitudinal rail standard - Focal Spot Travel - Transverse Travel 10.75 in. (27 cm) - Vertical Travel 62.75 in. (160 cm) - Minimum ceiling height = 87 in. (221 cm) - Pressure activated 180° column rotation - ±180° Tube rotation about the horizontal axis - Control buttons for the following actions: (located on the Control handle) - Longitudinal lock, Transverse lock, vertical lock, column rotation roll lock. All locks and automatic detent stops (both horizontal and vertical) - Centering detent aligns Focal Spot to image receptor - Electromagnetic locks 			
	COL-RALCO-M	<p>Ralco Certified Manual Collimator</p> <ul style="list-style-type: none"> - External adjustment of mirror angulation - High luminosity power LED for light field projection. LED cluster life: 50,000 hours - Timer that limits cluster ON time to 30 seconds - Radiation shielding: 150 kVp - 4 mA - Minimum inherent filtration 2mm aluminum equivalent. (1mm on request) - Continuous film coverage from min. 00 x 00cm to max. 48 x 48cm at 100cm FFD (SID) 	3		
	DM-CM50DR	<p>Del Medical CM Series DR 50kW, 630mA, High Frequency Three Phase Generator</p> <ul style="list-style-type: none"> - 150 kVp - Digital Interface for integration with Digital Radiography systems - Anatomical Programming with 768 programmable technique selections - one, two, or Three point technique selection - two Bucky Capability - power Cabinet with Auxiliary power Supply - Tube Protection Circuitry 	3		



KAS MEDICS LIMITED

Your Partner in Progressive Healthcare



TUBE-E7255-90	<ul style="list-style-type: none"> - Integrated service software assists in calibration and service - Self-diagnostic Circuitry with error code recording for fast trouble shooting Toshiba E7255FX Tube - 90° cable arms, 0.8x1.2mm FS, 300kHU, 150kVp, 12" target, 4 anode"	3	
DM-AEC-INT-2ION	AEC kit with interface board and two (2) Ion Chambers	3	
DM-CAB-HV-30	30' Generator High Voltage Cables, 150 kVp	3	
DM-RT100	Del Medical RT100 Table with Four-Way Float Top Item Features: <ul style="list-style-type: none"> - 700 lb. (318kg) patient load capacity - 86.5 x 31.9 Fiber-Resin table-top - 40in (102cm) Longitudinal Transverse table-top movement - Foot treadle lock controls for Longitudinal and Transverse table-top movement 	3	
DM-GC-TRAY	All-steel welded design for maximum strength and reliability Grid cabinet, 17 in. x 17 in. (43cm x 43cm) and One deluxe, heavy-duty manual cassette tray	3	
GRID-103-10-34	103 Line, 10:1 Ratio, 34-44" Grid	3	
DM-VS100	Del Medical VS100 Wall Stand (model 3546E) <ul style="list-style-type: none"> - Electromagnetic locks - Dual counterweight cables for added safety - Vertical travel range of 58.38 in. (148.28cm) - Height 86.75 in. (220.4cm) (includes vertical trav - Depth: 13 in. (33cm) - Width with receptor, 23.25 in. (59cm) - Depth with receptor, 13 in. (33cm) - Receptor height, 23.38 in. (59.4cm) - Maximum focal spot height, 72.38 in. (183.84cm) - Minimum focal spot height, 14 in. (35.6cm) - Weight, 258lb (117kg) - 0.4mm front panel aluminum equivalency - Power Requirements, 24 V DC 	3	
DM-GC-TRAY	Grid cabinet, 17 in. x 17 in. (43cm x 43cm) and One deluxe, heavy-duty manual cassette tray	3	
GRID-103-10-40	103 Line, 10:1 Ratio, 40-72" Grid	3	
DW-E14C-W	DelWorks E-Series DR System w/ one (1) 14x17" Wireless Cesium Detector, & EDR Workstation System Includes: <ul style="list-style-type: none"> - One (1) E14C Detector - One (1) Detector Configuration Cable - Two (2) Detector Batteries - One (1) 3-bay Battery Charger 	3	

KAS MEDICS LIMITED

Your Partner in Progressive Healthcare



- One (1) Wireless Access Point
- One (1) DelWorks Workstation PC & Software
- One (1) 23" Multi-Touch Display
- DelWorks E14C 14x17" Wireless Cesium Detector:
 - Detector Size: 14 x 17" (35 x 43cm)
 - Scintillator: Cesium Iodide (CsI)
 - Active Area: 13.8 x 16.8"
 - Pixel Matrix: 2400 x 2880
 - Pixel Pitch: 148 Micron
 - Dimensions: 15 x 18 x 0.6"
 - Weight: 6.17 lbs. w/ Battery
 - Bit Depth: 16 bit A/D
 - Image Display: 3-5 seconds
 - Cycle Time: 9 seconds
 - Exposure Window: Up to 3.2 seconds
 - Auto Exposure Detection: Yes
 - Limiting Resolution: 3.5lp/mm
- DelWorks Workstation Software:
 - Intuitive Technologist Exposure Guidance
 - Advanced image Processing and Algorithms
 - Image Reject Tracking and Analysis
 - CD/DVD/USB Drive Export/Output
 - DICOM Store, Print, and Modality Worklist
- DelWorks Workstation Hardware:
 - PC: Intel Core i5 3.2Ghz Processor, 16GB RAM, 1TB HD, DVD+/-RW, Windows 10
 - Professional 64-bit, Keyboard & Mouse
 - 23" Widescreen Multi-Touch Color Display

1149
CRPG
GLV
5102
5701M

6

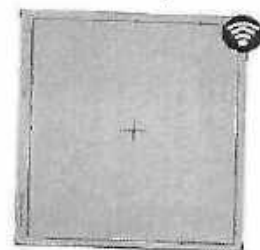

12
12
12
12
12

2 XFM

Mobile system for Digital Radiography (DR) with Wi-Fi Panel Detector

MANUFACTURER: ITALRAY - ITALY

HIGH-FREQUENCY GENERATOR

- > 100% microprocessor controlled high-frequency generator (40 kW) 40kW 500mA
- > kV range:40 – 125 kV Precision: 1kV
- > mA range 50 - 500 mA
- > Range mAs 0,5 - 400 mAs (27 steps)
- > kV-mA performance 320mA @ 60kV
- > Time range 0,001 - 6,3 s
- > Very short exposure times
- > Sharp images

X-RAY TUBE

Rotating anode dual focus 0.6-1.2 mm 300kHU

TRANSPORTABILITY

1

264,000,000.00

264,000,000.00



First floor warehouses Unit Nos. UF09 & UF10, Plot No. 11, Vingungiri Industrial Area,

P.O.Box 7956 Dar es Salaam Tanzania, Tel: +255 22 2861737/8

Email: info@kasmedics.com, www.kasmedics.com

KAS MEDICS LIMITED

Your Partner in Progressive Healthcare



- > Forwards and backwards fully motorized system movement (*)
- outstanding manoeuvrability
- one handed-driving

- > Highly reliable touch-less anti-collision system (*)
- > Motor Overboost for overcoming higher steps/ steeper ramps
- > Large rear wheels, and swivelling front wheels

INNOVATION OF DIGITAL TECHNOLOGY

- > Optimization of both image quality and patient dose
- > Full DICOM 3.0 package
- > Remote Service System for servicing and upgrading purposes

LIGHTWEIGHT AND WIRELESS

- > Wireless, cassette-size detectors [35x43 cm and 24x30 cm for pediatric use)
- > Grid encasement, for safe and effective grid examination (*)
- > Full capabilities also loaded with patient weight

COMPACT DESIGN

- > Easy passage through doors, corridors, elevator
- > Extremely light weight (< 300 kgs)
- > Limited overall dimensions
- > Good visibility during transportation

FLEXIBILITY

- > Rotating swivel arm with safe locking system
- > 90° freedom for lateral left-right arm rotation
- > +90° collimator rotation
- > Wireless SID measurement system with LCD display (*) > LED collimator light (*)

LARGE AND INTUITIVE TOUCH-SCREEN CONSOLE

- > Fully integrated solution with generator controls
- > 19" LCD high contrast touch-screen console
- > Intuitive interface for easy post processing
- > Operative also with protective gloves

EXTENSIVE OPERATION AND PORTABILITY

- > Long-life ultra-light Li-Ion battery for
- > 2 days of complete operativity (*)
- > Apron hanger
- > Versatile storage area
- > Additional filtration for pediatric exam
- > X-ray wireless pushbutton (*)

Image processed with everest-X



3 102642004

MyLab™ X5 Digital Ultrasound System

MANUFACTURER: ESAOTE - ITALY

The system is powered with EVO 3.0 SW Release.

The system is including:

- Built-in high resolution widescreen LCD Monitor with dual articulating arm (Optional) for 360 degree swivel
- Built-in high sensitivity and definition touch screen LCD display
- Alphanumeric keyboard on touchscreen
- Up to 3 transducers can be connected simultaneously – suitable for 2D/3D electronic probes and Doppler probes which can be switched directly from the keyboard

2

74,000,000.00

148,000,000.00

First floor, warehouses Unit No. UP09 & UP10, Plot No. 11, Vingunguti Industrial Area

P.O. Box 7856 Dar es Salaam Tanzania, Tel: +255 22 2861737/8

Email: info@kasmedics.com, www.kasmedics.com

KAS MEDICS LIMITED

Your Partner in Progressive Healthcare



- The system supports any type of probes: convex, microconvex, linear, phased array, volumetric, Doppler and special probes
 - IQ advanced technology transducers featuring an ergonomic exclusive design.
 - Built-in CD/DVD burner
 - On-board partitioned and expandable hard disk
 - LAN and USB data ports as well as Physio and other interfaces for peripheral devices
 - Wireless connection (Optional)
 - B-mode/M-Mode/CFM/Doppler/Power Doppler
 - Auto Adjust function to automatically optimize B-mode, Spectral Doppler and Color Doppler images
 - B-Mode/CFM/Doppler Independent beam steering
 - CMM (Compass M-Mode) up to three lines realtime directional M-Mode
 - TEI, Tissue Enhancement Imaging
 - XView, innovative and real-time adaptive algorithm customizable for speckle reduction
 - HD Color Doppler (CFM) and Power Doppler (PDI) as well as Directional Power Doppler (DPDI) with high sensitivity and definition.
 - TVM, Tissue Velocity Mode (included in Cardio Package)
 - PW Doppler, HPRF and CW
 - XFlow to increase sensitivity and resolution with blood flow imaging
 - Real time Triplex mode available on all probes
 - Cine Memory and Cine Loops module
 - Raw Data Processing from Archive
 - Real time Dual Mode Imaging
 - On-board real-time patient data archive with images, video clips, reports and medical records
 - High definition read-write Zoom and HD Zoom module
 - eTouch, your favourite preset functions and settings with a single click
 - Calculation and measurement software (including automatic ones) with structured reports for all applications
 - Unlimited number of customizable presets which can be stored
 - TpView, Trapezoid Imaging display
 - VPan, Panoramic imaging display
 - MView, Multiangle Compound Imaging (Optional)
 - Protocols, fully operator configurable
 - Respirometer (Breathing Curve), requires ecg cable to work
 - Dicom (optional) with all supported class: Store SCU, Printer, Worklist, Query-Retrieve, IHE compliant
 - Multi-modality Archive & Dicom Q/R (optional)
 - Ultrasound Imaging Viewer, MyLabDeskEVO, available for download from the system
 - Remote Service capability
- 21.5" LCD Monitor



15000027



First floor warehouses Unit No UF09 & UF10, Plot No 11, Vingunguti Industrial Area

P.O Box 7856 Dar es Salaam Tanzania, Tel +255 22 2861737/8

Email: info@kasmedics.com, www.kasmedics.com

SECTION F: TECHNICAL SPECIFICATIONS AND DRAWINGS



**TECHNICAL REQUIREMENTS AND SPECIFICATIONS FOR SUPPLY,
INSTALLATION AND COMMISSIONING OF DIGITAL X RAY AT MTWARA ZONAL
HOSPITAL**

SN	EQUIPMENT NAME	MINIMUM TECHNICAL SPECIFICATION
1	Digital x ray	<p>Line nominal, phase</p> <ol style="list-style-type: none"> 1) 220V/230VAC, 1ϕ±10% 2) 380/400/480VAC, 3ϕ, ±10% <ul style="list-style-type: none"> • Output rating : 32Kw • Line frequency : 50/60Hz • Kv range : 40~125Kv, 1Kv step • Ma range : 10 to 400Ma • Timer range : 0.001 to 10 sec, 38 steps • mAs range : 0.1 to 500mAs • Rotor supply : low speed • Max. power output : 400Ma@50kv • -Reproducibility <p>: Coefficient of variation : Kv<0.005, Time<0.005, mAs < 0.01</p> <p>- Accuracy : Kv<±(1%+1Kv), Ma<±(3%+1Ma), time<±(1%+0.5ms), mAs<±(3% +0.1mAs)</p> <p>- Linearity : coefficient of linearity<0.01 : CL=(X1-X2)/(X1+X2), where X is Mr / mAs</p> <p>Consist of</p> <ul style="list-style-type: none"> - Digital diagnostic X-ray System, 32Kw, 125Kv, 400Ma and 2 Flat Panel Detectors included <p>below parts : 1 set</p> <ol style="list-style-type: none"> 1) X-ray Generator : 32Kw, 125kVp, 400Ma, 1ϕ 230VAC±10% input : 1ea 2) Flat Panel Detector: 17x17inch, wired, CsI : 2ea 3) TS-FC6: Floor Ceiling Rail Type : 1ea 4) X-ray Tube: 0.6/1.5mm, 200Khu : 1ea 5) PBT-4: Floating Tabletop Table with Rotating tray : 1ea 6) WBS: Wall Bucky Stand with Rotating tray : 1ea 7) Grid: High Line DR grid at Table and WBS : 2ea 8) MCR: Manual Collimator : 1ea 9) HVC-8: 8 meters HV cable, pair : 1ea 10) Workstation with S/W and LED monitor : 1ea 11) AEC board with 2 Ion chamber at Table and WBS : 1ea 12) Standard Packing for Export : 1ea



**TECHNICAL REQUIREMENTS AND SPECIFICATIONS FOR SUPPLY,
INSTALLATION AND COMMISSIONING OF DIGITAL X RAY AT MOROGORO RHH**

Equipment Description	Technical specifications
Digital X-ray	<p>This Machine should be able to provide a minimum of 300 images per day. Should have a high frequency generator of 50-150KW, Automatic exposure device, Anatomical programming radiography, overloading protection feature, digital display of KV and mAs. X-Ray tube should be Floor stand mounted.</p> <p>Axis should rotate 360 degree</p> <p>Five years comprehensive Maintenance inclusive.</p> <p>High speed rotating anode and exposure should be 50 – 150KV and 0-600mA. Heat strength capacity of the anode at least 150,000HU.</p> <p>The digital detector (Two fixed Detectors) should be flat panel of latest technology.</p> <p>The digital workstation should have high speed processors, preview time of 5s or less.</p> <p>The workstation should provide basic functions for image processing and be compatible to other HIS</p> <p>Displayed Parameters: The console monitor should display patient ID, Exposure factors, warning sign and other important parameters.</p> <p>Components: Patient table: Mounted on heavy duty four castors with brakes to allow Longitudinal and lateral movement and better patient position. Floating table with up and down movement Table Size from 1800x800mm to 2200x800mm Patient weight: at least 150Kg</p> <p>Bucky wall stand: Height :1900mm</p> <p>Center Height Stroke Range from 400mm to 1600mm</p> <p>Source to image detector should include the range of 90cm to 125cm</p> <p>Detectors:</p> <p>Fixed Flat Panel Detectors</p> <p>Active Image Size at least 17inch x 17inch or 43cm x 43cm</p> <p>Pixel Size at least 140 micron</p> <p>Dimension : 460 x 460 x 15mm</p> <p>Dust cover for control unit to be supplied.</p> <p>Protection against insect and rodent ingress to be incorporated.</p>



Equipment Description	Technical specifications
	<p>Electrical Requirements: Should meet Tanzania Electrical Standards (Voltage of between 220-240V with the standard frequency of 50Hz) with type G adaptor System.</p> <p>Accessories: Multi-tray printer for different X-Ray film sizes (10 x 12, 14 x14, 14 x 17, 10 x 8). Protective gear (lead apron minimum of 2 small, 2 medium and 2 large), Goggles (Minimum 1 small, 1 medium and 1 large). Gonad shield (minimum 2 small, 2 medium, 2 large), neck collar shield (minimum of 1small, 1 medium, 1 large), Gloves (Minimum 2 small, 2 medium and 2 large). Radiation hazards warning signs to be supplied with the machine. It should come with the Power Backup System with capacity of power storage for not less than 15 Minutes.</p> <p>Radiation protective gears: X-ray should come with;(i) two (2) pairs of lead aprons with back protection 0.35/0.25mmPb, (ii) two (2) pairs of Thyroid Shield Model Classic 0.35mmPb (iii) two (2) pairs of Patient Apron with belt 0.50mmPb Leadlite W/G-30 L-30</p> <p>Printer</p> <p>Multi-tray printer for different X-Ray film sizes (10 x 12, 14 x14, 14 x 17, 10 x 8).</p> <p>Training, Installation and Utilization</p> <p>Requirements for commissioning: Manufacturer/supplier should perform installation, safety and operation checks before handover. Acceptance tests to be specified and local clinical and technical staff to verify proper and full functioning of device.</p> <p>Training of user/s: Application specialist shall provide training of users in operation and basic maintenance.</p> <p>Warranty and Maintenance:</p> <p>Five years comprehensive maintenance should include service, spare parts and labour starting from the day of the acceptance testing of the machine.</p> <p>Lifetime support; spare parts, consumables should be available throughout the lifetime period of the machine.</p>



Equipment Description	Technical specifications
	<p>Uptake time should be a minimum of 90%.</p> <p>Proof of locally available technical support personnel, including CVs and work permit for foreign personnel.</p> <p>Availability of technical personnel within the country should be stated; this should include CVs, work permits for foreign personnel.</p> <p>Software should be flexible and provide the room for upgrade to add new parameters to be measured by the Machine and report format.</p> <p>Documentation: Operating and service manuals (In English) including lists of important spares and accessories - with their part numbers and list of equipment and procedures required for calibration and routine maintenance should be provided. Documentation must also show recommended procedures for disposal and any probable hazards to the environment and/or community.</p> <p>Life span: Life span of the machine should be not less than 10 Years.</p> <p>Risk Classification: As per ISO 14971:2007- Application of risk management to medical devices.</p> <p>Regulatory Approval / Certification: TAEC, TBS and TFDA</p>



S. I	EQUIPMENT NAME	QUANTITY	MINIMUM TECHNICAL SPECIFICATION
1	Mobile Digital x-ray	1	<ul style="list-style-type: none"> • Mobile x-ray of latest technology • Basic radiologic system (BRS); Digital radiography; Electronically recorded digital radiography; General radiographic x-ray equipment; Radiographic unit, chest; Radiographic unit, general-purpose; • Provides X-ray film images of all parts of the body including the skull, spine, pelvis, chest, abdomen and extremities. • Should meet Tanzania Electrical Standards (voltage of between 220-240 V and the standard frequency of 50-60 Hz) with type G adaptor System. • DICOM compatible image storage and transfer
2	Advanced Ultrasound Machine	2	<p>Feature</p> <p>Dual Live Side by Side Display</p> <ul style="list-style-type: none"> • Tissue Harmonic Imaging • Automatic optimization of the image, and the spectrum Triplex • Multi-view spatial compounding option that increases contrast resolution and improves tissue differentiation of low contrast lesions by reducing image speckle • Speckle Reduction technique • Spatial compounding option <p>General Specifications</p> <ul style="list-style-type: none"> • Lightweight and ergonomic design • Screen: 15" high resolution color or higher • 3 active probe ports • Dual footswitch • Thermal color printer • Imaging processing and presentation • Digital beam former 16,000 channels • Beam former operating frequency range : 1 –15 MHz • System internal dynamic range > 150 Db • Maximum penetration depth: 30 cm • Zoom in pre and post processing • Max Frame rate > 700 fps <p>Operating modes</p> <ul style="list-style-type: none"> • B-mode • M-Mode • Anatomical M- Mode • M-Mode flow modes • Color Flow Doppler mode

S. I	EQUIPMENT NAME	QUANTITY	MINIMUM TECHNICAL SPECIFICATION
			<ul style="list-style-type: none"> • Power Doppler mode • Power Doppler with high PRF • HD Flow Doppler • Pulse wave Mode • 3D and 4D real time • Tissue Doppler • Extended View Measurements, calculations • Detailed calculations and formulas following the applications. • Auto Measurements Probes • Volume sweep probe: • Supports 2D, 3D, 4D , THI, Color Doppler, Power Doppler, PW Doppler and M-Mode • Bandwidth: min. 1-5 MHz • Wideband linear array probe: • Bandwidth: min. 4-12 MHz • Wideband convex array probe • Bandwidth: min. 2-5 MHz • Endo cavity convex array probe • Bandwidth: min. 4-10 MHz Connectivity • Internal database – Patient Archive • Worksheet • Memory supports available : CD, DVD, USB • memory device • Archiving format : DICOM, JPEG, AVI, MPEG • DICOM Storage <ul style="list-style-type: none"> - DICOM Print • Standards (voltage of between 220-240 V and the standard frequency of 50-Hz) with type G adaptor System. •



KAS MEDICS LIMITED

Your partner in progressive healthcare



STATEMENT OF COMPLIANCE

**SUPPLY, INSTALLATION, TETSING, COMMISSIONING AND TRAINING OF DIGITAL X RAY
FOR MOROGORO RHH,**

IFT NO. PA-010/2021-2022/G/37

DATE: 05TH DECEMBER, 2021

A handwritten signature in black ink, consisting of several loops and a horizontal line.

KAS MEDICS LIMITED

Your partner in progressive healthcare



EQUIPMENT DESCRIPTION	TECHNICAL SPECIFICATIONS	COMPLY
Digital X-ray	This Machine should be able to provide a minimum of 300 images per day.	COMPLY
DM-FMT Floor Mounted Radiographic System	<ul style="list-style-type: none"> Should have a high frequency generator of 50-150KW, Automatic exposure device, Anatomical programming radiography, overloading protection feature, digital display of KV and mAs. 	Complied
	<ul style="list-style-type: none"> X-Ray tube should be Floor stand mounted. 	Complied
	<ul style="list-style-type: none"> Axis should rotate 360degree 	Complied
	<ul style="list-style-type: none"> Five years comprehensive Maintenance inclusive. 	Complied
	<ul style="list-style-type: none"> High speed rotating anode and exposure should be 50 – 150KV and 0-600mA. 	Complied
	<ul style="list-style-type: none"> Heat strength capacity of the anode at least 150,000HU. 	Complied
	<ul style="list-style-type: none"> The digital detector (Two fixed Detectors) should be flat panel of latest technology. 	Complied
	<ul style="list-style-type: none"> The digital workstation should have high speed processors, preview time of 5s or less. 	Complied
	<ul style="list-style-type: none"> The workstation should provide basic functions for image processing and be compatible to other HIS 	Complied
	<ul style="list-style-type: none"> Displayed Parameters: 	Complied
	<ul style="list-style-type: none"> The console monitor should display: 	Complied
	<ul style="list-style-type: none"> patient ID, Exposure factors, warning sign and other important parameters. 	Complied
	<ul style="list-style-type: none"> Components: Patient table: 	
	<ul style="list-style-type: none"> Mounted on heavy duty four castors with brakes to allow Longitudinal and lateral movement and better patient position. Floating table with up and down movement. Table Size from 1800x800mm to 2200x800mm 	Complied
	<ul style="list-style-type: none"> Patient weight: at least 150Kg 	Complied
	<ul style="list-style-type: none"> Bucky wall stand: Height :1900mm 	Complied
	<ul style="list-style-type: none"> Center Height Stroke Range from 400mm to 1600mm 	Complied
	<ul style="list-style-type: none"> Source to image detector should include the range of 90cm to 125cm 	Complied
	<ul style="list-style-type: none"> Detectors: 	Complied
	<ul style="list-style-type: none"> Fixed Flat Panel Detectors 	Complied
<ul style="list-style-type: none"> Active Image Size at least 17inch x 17inch or 43cm x 43cm 	Complied	
<ul style="list-style-type: none"> Pixel Size at least 140 micron 	Complied	
<ul style="list-style-type: none"> Dimension: 460 x 460 x 15mm 	Complied	
<ul style="list-style-type: none"> Dust cover for control unit to be supplied. 	Complied	
<ul style="list-style-type: none"> Protection against insect and rodent ingress to be incorporated. 	Complied	
<ul style="list-style-type: none"> Electrical Requirements: 	Complied	
<ul style="list-style-type: none"> Should meet Tanzania Electrical Standards (Voltage of between 220-240V with the standard frequency of 50Hz) with type G adaptor System. 	Complied	

KAS MEDICS LIMITED

Your partner in progressive healthcare



Accessories:	
<ul style="list-style-type: none"> Multi-tray printer for different X-Ray film sizes (10 x 12, 14 x 14, 14 x 17, 10 x 8). Protective gear (lead apron minimum of 2 small, 2 medium and 2 large), Goggles (Minimum 1 small, 1 medium and 1 large). Gonad shield (minimum 2 small, 2 medium, 2 large), neck collar shield (minimum of 1small, 1 medium, 1 large), Gloves (Minimum 2 small, 2 medium and 2 large). Radiation hazards warning signs to be supplied with the machine. It should come with the Power Backup System with capacity of power storage for not less than 15 Minutes. 	Complied
Radiation protective gears:	Complied
<ul style="list-style-type: none"> X-ray should come with;(i) two (2) pairs of lead aprons with back protection 0.35/0.25mmPb, (ii) two (2) pairs of Thyroid Shield Model Classic 0.35mmPb (iii) two (2) pairs of Patient Apron with belt 0.50mmPb Leadlite W/G-30 L-30 	Complied
Printer	Complied
Multi-tray printer for different X-Ray film sizes (10 x 12, 14 x 14, 14 x 17, 10 x 8).	Complied
Training, Installation and Utilization	Complied
<ul style="list-style-type: none"> Requirements for commissioning: Manufacturer/supplier should perform installation, safety and operation checks before handover. Acceptance tests to be specified and local clinical and technical staff to verify proper and full functioning of device. 	Complied
Training of user/s: Application specialist shall provide training of users in operation and basic maintenance.	Complied
Warranty and Maintenance:	Complied
<ul style="list-style-type: none"> Five years comprehensive maintenance should include service, spare parts and labour starting from the day of the acceptance testing of the machine. 	Complied
<ul style="list-style-type: none"> Lifetime support; spare parts, consumables should be available throughout the lifetime period of the machine. 	Complied
<ul style="list-style-type: none"> Uptake time should be a minimum of 90%. 	Complied
<ul style="list-style-type: none"> Proof of locally available technical support personnel, including CVs and work permit for foreign personnel. 	Complied
<ul style="list-style-type: none"> Availability of technical personnel within the country should be stated; this should include CVs, work permits for foreign personnel. 	Complied
<ul style="list-style-type: none"> Software should be flexible and provide the room for upgrade to add new parameters to be measured by the Machine and report format. 	Complied
Documentation:	Complied
<ul style="list-style-type: none"> Operating and service manuals (In English) including lists of important spares and accessories - (with their part numbers and list of equipment and procedures required for calibration and routine maintenance should be provided). Documentation must also show recommended procedures for disposal and any probable hazards to the environment and/or community. 	Complied
Life span:	Complied
<ul style="list-style-type: none"> Life span of the machine should be not less than 10 Years. 	Complied
<ul style="list-style-type: none"> Risk Classification: As per ISO 14971:2007- Application of risk management to medical devices. 	Complied
<ul style="list-style-type: none"> Regulatory Approval / Certification: TAEC, TBS and TFDA 	Complied

KAS MEDICS LIMITED

Your partner in progressive healthcare



Authorized Signature:  KAS MEDICS LTD.
P. O. Box 7856
DAR-ES-SALAAM
TANZANIA

Name and Title of Signatory: Charles Lintu
in the Capacity of Sales Administrative Executive

Name of Tenderer: Kas Medics Ltd Address: P. O. Box 7856, Dar-Es-Salaam.

Date: 05th December, 2021

A handwritten signature, likely of Charles Lintu, located at the bottom center of the page.

DEL MEDICAL

FMT

FLOOR MOUNTED
RADIOGRAPHIC SYSTEM

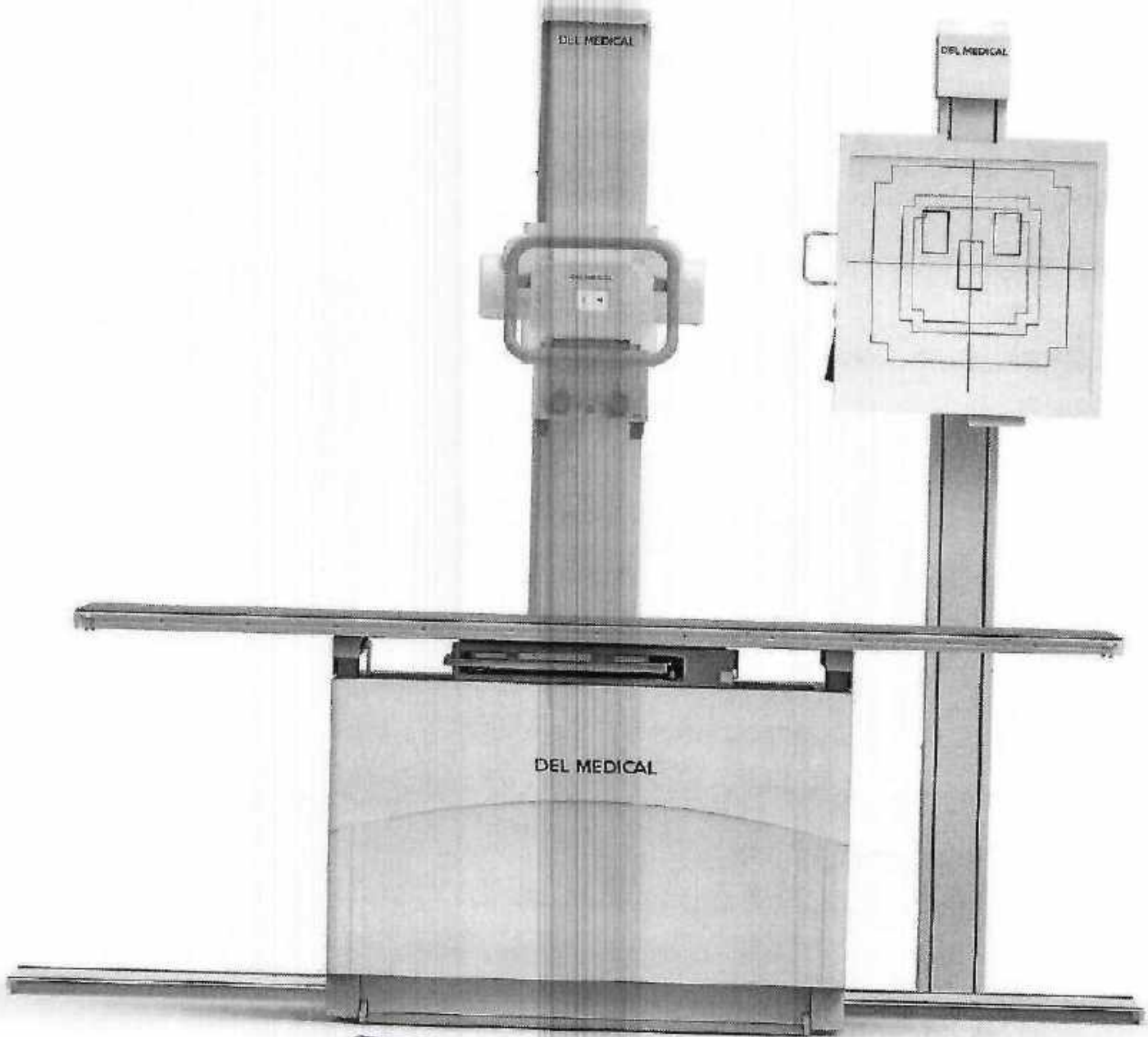

000

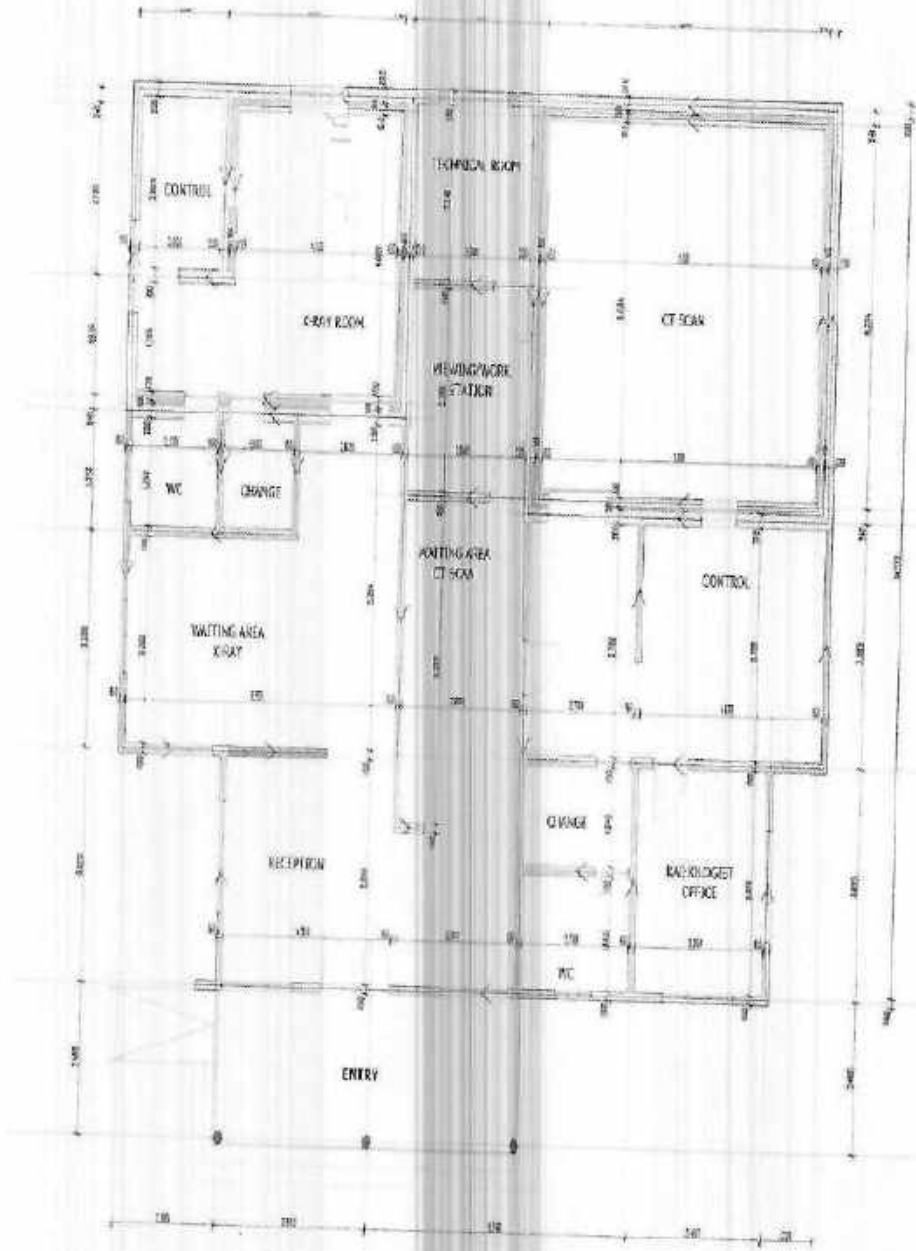

PROPOSED X-RAY AND CT SCAN BUILDING

KAS MEDICS LIMITED

Your partner in progressive healthcare



STATEMENT OF COMPLIANCE

**SUPPLY, INSTALLATION, TETSING, COMMISSIONING AND TRAINING OF DIGITAL X RAY
FOR MTWARA ZONAL HOSPITAL,**

IFT NO. PA-010/2021-2022/G/37

DATE: 05TH DECEMBER, 2021

A handwritten signature in black ink, consisting of several loops and a long horizontal stroke.

KAS MEDICS LIMITED

Your partner in progressive healthcare



EQUIPMENT DESCRIPTION	TECHNICAL SPECIFICATIONS	COMPLY
Digital X-Ray Machine DM-FMT Floor Mounted Radiographic System	Line nominal, phase	Complied
	1) 220V/230VAC, 1Ø±10%	Complied
	2) 380/400/480VAC, 3Ø, ±10%	Complied
	▪ Output rating : 32Kw	Complied
	▪ Line frequency : 50/60Hz	Complied
	▪ Kv range : 40~125Kv, 1Kv step	Complied
	▪ Ma range : 10 to 400Ma	Complied
	▪ Timer range : 0.001 to 10 sec, 38 steps	Complied
	▪ mAs range : 0.1 to 500mAs	Complied
	▪ Rotor supply : low speed	Complied
	▪ Max. power output : 400Ma@50kV	Complied
	Reproducibility	
	Coefficient of variation : Kv<0.005, Time<0.005, mAs < 0.01	Complied
	Accuracy: : Kv<±(1%+1Kv), Ma<±(3%+1Ma), time<±(1%+0.5ms), mAs<±(3% +0.1mAs)	Complied
	Linearity : coefficient of linearity<0.01 : GL=(X1-X2) / (X1+X2), where X is Mr / mAs	Complied
	Consist of	
	Digital diagnostic X-ray System, 32Kw, 125Kv, 400Ma and 2 Flat Panel Detectors included below parts: 1 set	Complied
	1) X-ray Generator: 32Kw, 125kVp, 400Ma, 1Ø 230VAC±10% input: 1ea	Complied
	2) Flat Panel Detector: 17x17inch, wired, Csf: 2ea	Complied
	3) TS-FC6: Floor Ceiling Rail Type: 1ea	Complied
4) X-ray Tube: 0.6/1.5mm, 200Khu: 1ea	Complied	
5) PBT-4: Floating Tabletop Table with Rotating tray: 1ea	Complied	
6) WBS: Wall Bucky Stand with Rotating tray: 1ea	Complied	
7) Grid: High Line DR grid at Table and WBS: 2ea	Complied	
8) MCR: Manual Collimator: 1ea	Complied	
9) HVC-8: 8 meters HV cable, pair: 1ea	Complied	
10) Workstation with SW and LED monitor: 1ea	Complied	
11) AEC board with 2 Ion chamber at Table and WBS: 1ea	Complied	
12) Standard Packing for Export : 1ea	Complied	

Authorized Signature: _____

Name and Title of Signatory: Charles Lintu

In the Capacity of Sales Administrative Executive

Name of Tenderer: Kas Medics Ltd Address: P. O. Box 7856, Dar-Es-Salaam.

Date: 05th December, 2021

KAS MEDICS LTD.
P. O. Box 7856
DAR-ES-SALAAM
TANZANIA

DEL MEDICAL

FMT

FLOOR MOUNTED
RADIOGRAPHIC SYSTEM

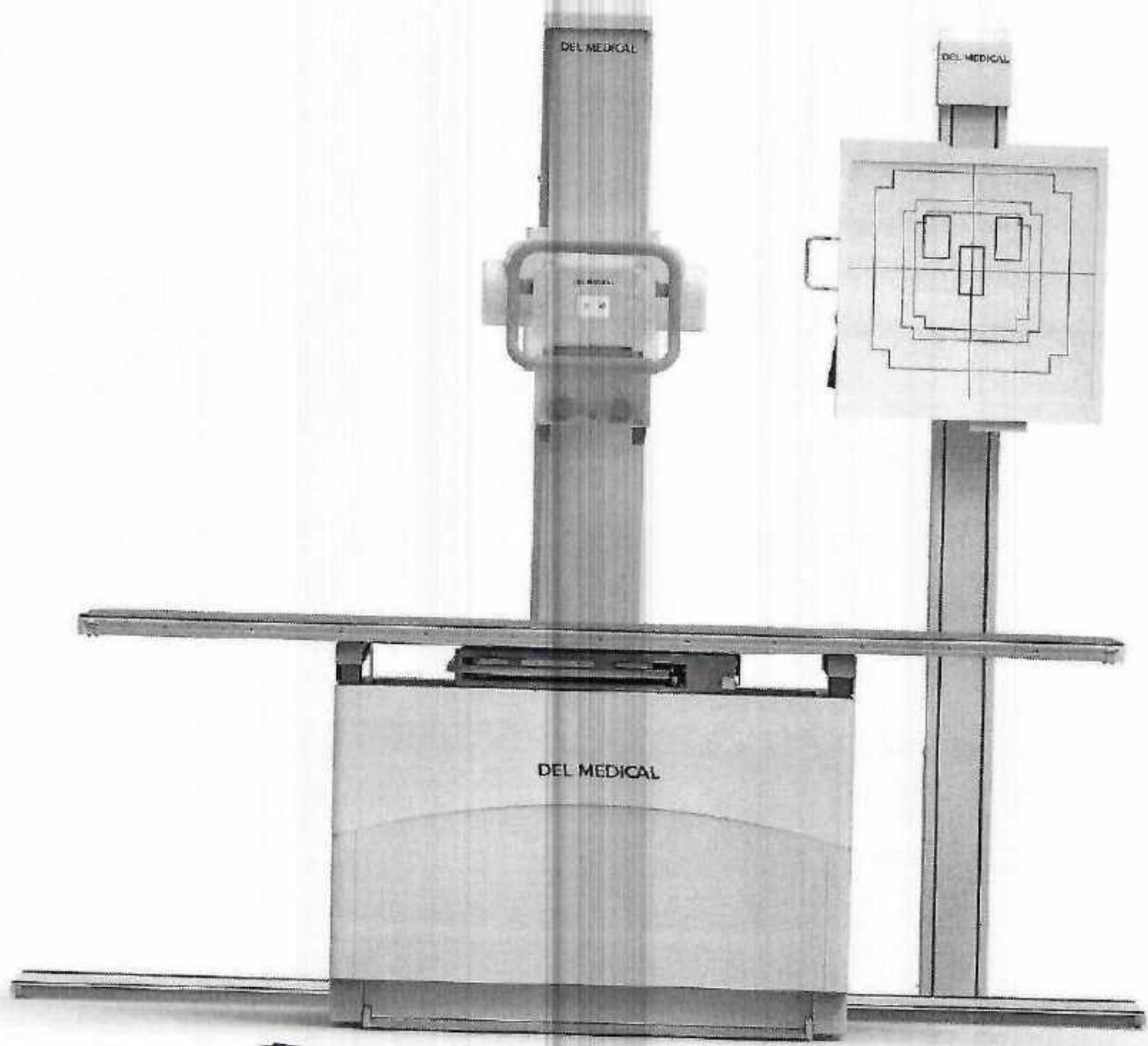

NEGOTIATION MEETING

Venue: Executive Director Board Room

Date: 07/12/2021

Quotation no: **PA-010/2021-22/G/37** for Supply of Digital X ray for Mtwara Zonal and Morogoro RHH.

Attendance:

1. Gabriel Sungi	Chairman	ORCI
2. Hamis Malima	Member	ORCI
3. Mohamed Mbwana	Member	ORCI
4. Dominic Mbithi	Member	KAS MEDICS
5. Revellian Iramu	Secretary	ORCI
6. Joshua Mmari	Member	ORCI

Agenda:

1. Opening of the meeting
2. Adoption of the Agenda
3. Discussion on areas for technical and financial negotiation
4. AOB
5. Closing of the meeting

1. Opening of the meeting:

The meeting was opened by the chairman of negotiation team at 03:24 PM, the chairman welcomed all members including the representative from KAS MEDICS LIMITED to introduce themselves, which they all complied. The chairman went on to explain the purpose of the meeting and proceeded to Agenda number 2.

2. Adoption of the Agenda

All agenda were read out and confirmed



3. Discussion on areas for technical and financial negotiation

The quoted price for the supply of these medical equipments were read out at the meeting to be 870,000,000.00 against the budget allocation of TZS 2,160,000,000, However, due to the Supplier being unclear on the provision of two fixed detectors and the wish for Mtwara Zonal Hospital to request additional Mobile X ray and two Advanced Ultrasound, this necessitated to have the negotiation between ORCI and KAS MEDICS.

The chairman welcomed the technical personnel representing ORCI, who requested clarification about fixed double detectors. KAS MEDICS representatives, replied on affirmative, that the X ray brough have Fixed double detectors and are both on Five years warranty. The specifications were checked and were in line with the specifications provided in the bid documents.

Additional requests for Mobile X ray and Advanced ultrasound were discussed, and the Supplier complied within the specifications requested by the Users.

The supplier was requested to provide a discount on both supplies and went on to reduce 10,000,000/= from the mobile x ray and TZS 1,000,000/= from the supply of Digital Xray. The break down for the budget and cost are as follows:

S/n	Item Description	Mtwara Zonal	Morogoro RHH
1	Budget for X Ray	840,000,000	420,000,000
2	Quote by Supplier@290,000,000	580,000,000	290,000,000
	Additional Requirement on Mtwara Zonal		
1	Mobile X ray cost	264,000,000	N/A
2	2 Advanced Ultrasound cost	148,000,000	N/A
	Total Mobile X ray and Ultrasound	412,000,000	



4. AOB

The committee agreed with the supplier on the quote for the sale of Digital X ray at TZS 290,000,000, hence the cost for the supply of three Digital X ray will be at TZS 870,000,000, also it was agreed on the cost for Mobile X Ray at TZS 264,000,000 and it was agreed on the cost for digital ultrasound be at TZS 74,000,000, hence for two ultrasound it was TZS 148,000,000/=. The supplier was requested to send in the proforma with the total cost of contract be TZS **1,282,000,000/=** and await the reward by Tender board.

5. Closing of the meeting

The meeting was concluded at 11:45 PM, notification of the award will be awarded after Tender board approval of the negotiation agreement reached.

Prepared by:



.....

Mohamed Mbwana
Secretary
Ocean Road Cancer Institute

Approved by:

.....

CPA Gabriel Sungi
Chairman
Ocean Road Cancer Institute

.....







Dominic Mbithi/
Representative
KAS MEDICS LTD

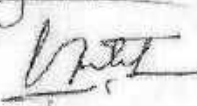

Negotiation Meeting

Digital X-ray.

7/12/2021

<u>S/N</u>	<u>Name</u>	<u>Role</u>	<u>Signature</u>
1.	Cesairel Sanyr	Chairman	
2.	Mohamed M. Lwansa	Secretary	
3.	DR. RENEUVAN S. IYIMU	Member	
4.	Joshua Mwan	Member	
5.	DOMINIC MBITHI	Supplier (KAS MEDICALS LTD)	
6.	Harriet MURKINIA	Member	



KAS MEDICS LIMITED

Your partner in progressive healthcare

KAS

SPECIAL POWER OF ATTORNEY

Date: 04th December, 2021.

To:
Executive Director,
Ocean Road Cancer Institute – ORCI,
P. O. Box 3592,
DAR ES SALAAM TANZANIA.

THAT BY THIS POWER OF ATTORNEY given on the 04th December, 2021.
WE the undersigned **KAS MEDICS LIMITED** of **Vingunguti Industrial Area, Plot No. 11, Umoja Complex Warehouse, 1st Floor, UF09&10**, by virtue of authority conferred to us, do hereby ordain nominate and appoint **CHARLES LINTU** of **P. O. Box 7856 Dar Es Salaam**, to be our true lawful Attorney and Agent, with full power and authority, for us and in our names, and for our accounts and benefits, to do any, or all of the following acts, in the execution of the **Tender No. PA-010/2021-2022/G/37** for **Supply, Installation and Commissioning of Digital X Ray for Mtwara Zonal and Morogoro RHH** that is to say;

To act for the company and do any other thing or things incidental for **Tender No. PA-010/2021-2022/G/37** for **Supply, Installation and Commissioning of Digital X-Ray for Mtwara Zonal and Morogoro RHH**

AND provided always that this Power of Attorney shall not revoke or in any manner affect any future power of attorney given to any other person or persons for such other power or powers shall remain and be of the same force and affect as if this deed has not been executed.

AND we hereby undertake to ratify everything, which our Attorney or any substitute or substitutes or agent or agents appointed by him under this power on his behalf herein before contained shall do or purport to do in virtue of this Power of Attorney.

SEALED with the common seal of the said **KAS MEDICS LIMITED** and delivered in the presence of us this 04th day of **December, 2021**.

IN WITNESS whereof we have signed this deed on this 04th day of **December, 2021**, at **Vingunguti Industrial Area, Plot No. 11, Umoja Complex Warehouse, 1st Floor, UF09&10** for and on behalf of **KAS MEDICS LIMITED**

SEALED and DELIVERED by the
Common Seal of **KAS MEDICS LIMITED**
This
04th day of **December, 2021**.

DONOR (signature)

BEFORE ME: -

COMMISSIONER FOR OATHS



KAS MEDICS LTD.
P. O. Box 7856
DAR-ES-SALAAM
TANZANIA

First Floor, Plot 11, Warehouse UF09 & UF10, Vingunguti Industrial Area, along Nyerere Road P.O.Box 7856 Dar es Salaam Tanzania

Tel: 255 22 2881737 Mobile: 255 877 01 81 00 Email: info@kasmedics.com

www.kasmedics.com

KAS MEDICS LIMITED

Your partner in progressive healthcare

KAS

ACKNOWLEDGEMENT

I **CHARLES LINTU** do hereby acknowledge and accept to be Attorney of the said **KAS MEDICS LIMITED** under the terms and conditions contained in this **POWER OF ATTORNEY** and I promise to perform and discharge my duties as the lawfully appointed Attorney faithfully and honestly.

SIGNED AND DELIVERED by the said
CHARLES LINTU Identified to me

by **PADAM DAS**
The latter known to me personally
This 04th day of **December, 2021**.



.....
DONEE

BEFORE ME



.....
COMMISSIONER FOR OATHS

KAS MEDICS LTD.
P. O. Box 7856
DAR-ES-SALAAM
TANZANIA

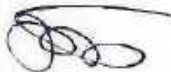

First Floor, Plot 11, Warehouse UF09 & UF10, Vingunguti Industrial Area, along Nyerere Road P.O.Box 7856 Dar es Salaam Tanzania

Tel: 255 22 2861137 Mobile +255 677 01 81 80 Email: info@kasmedics.com

www.kasmedics.com

Tender Securing Declaration

Date: 04th December, 2021

Tender No.: PA-010/2021-2022/G/37

To:

Executive Director,
Ocean Road Cancer Institute – ORCI,
P. O. Box 3592,
DAR ES SALAAM TANZANIA.

We, the undersigned, declare that:

We understand that, according to your conditions, Tenders must be supported by a Tender-
Securing Declaration.

We accept that we will automatically be suspended from being eligible for tendering in any
contract with the PE for the period of time determined by the Authority, if we are in breach
of our obligation(s) under the Tender conditions, because we:

- (a) have withdrawn our Tender during the period of Tender validity specified in the Form
of Tender; or
- (b) having been notified of the acceptance of our Tender by the Purchaser during the
period of Tender validity, (i) fail or refuse to execute the Contract, if required, or (ii)
fail or refuse to furnish the Performance Security, in accordance with the ITB.

We understand this Tender Securing Declaration shall expire if we are not the successful
Tenderer, upon the earlier of (i) our receipt of your notification to us of the name of the
successful Tenderer; or (ii) twenty-eight days after the expiration of our Tender

Signed:  _____
KAS MEDICS LTD.
P. O. Box 7856
DAR-ES-SALAAM
TANZANIA

Name: Charles Lintu in the Capacity of Sales Administrative Executive

Duly authorized to sign the Tender for and on behalf of Kas Medics Limited

Dated: 04th day of December, 2021.

Attested by me: -

 _____
Advocate:

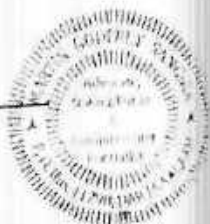

KAS MEDICS LIMITED

Your partner in progressive healthcare



UNDERTAKING BY TENDERER ON ANTI - BRIBERY POLICY/ CODE OF CONDUCT AND COMPLIANCE PROGRAMME (Made under Regulation 78 (2) of GN 446 of 2013)

(Regulation 78 (2) of the Public Procurement Regulations, 2013 - Government Notice No. 446 of 2013)

This company **KAS MEDICS Ltd** places importance on competitive Tendering taking place on a basis that is free, fair, competitive and not open to abuse. It is pleased to confirm that it will not offer or facilitate, directly or indirectly, any improper inducement or reward to any public officer their relations or business associates, in connection with its Tender, or in the subsequent performance of the contract if it is successful.

This company has an Anti-Bribery Policy/Code of Conduct and a Compliance Program which includes all reasonable steps necessary to assure that the No-bribery commitment given in this statement will be complied with by its managers and employees, as well as by all third parties working with this company on the public sector projects, or contract including agents, consultants, consortium partners, sub- contractors and Laboratory Supplies Manufacturer's. Copies of our Anti-Bribery Policy/Code of Conduct and Compliance Program are attached

Signed:  **KAS MEDICS LTD.**
P. O. Box 7856
DAR-ES-SALAAM
TANZANIA

Name and Title of Signatory: **CHARLES LINTU** in the Capacity of **Sales Administrative Executive**

Name of Tenderer: **Kas Medics Ltd**

Date: **04th December, 2021.**

Address: **P. O. Box 7856, Dar-Es-Salaam.**



First Floor, Plot 11, Warehouse UF09 & UF10, Vingunguli Industrial Area, along Nyerere Road P.O.Box 7856 Dar es Salaam Tanzania

Tel: +255 22 2861937/8 Mobile: +255 677 015111 Email: info@kasmedics.com

www.kasmedics.com

Box 7856 DSM
GR: 18097

WING/46204/22

IPN. 226
(Rev. 2/96)



JAMHURI YA MUUNGANO WA TANZANIA

PID - 201900781245
BID - 1821

LESENI YA BIASHARA

B 3846204

(Inetolewa chini ya Sheria ya Leseni za Biashara Na. 25 ya Mwaka 1972 marakebisho ya mwaka 1980 na masharti yaliyo nyuma)

*Futa isiyotakiwa.

1. Ofisi iliyotolewa MANISPAA - ILALO
2. Nambari ya Ushuri wa mepato 100 - 107 - 724
3. Leseni imejolewa kwa KOS MEDICS LIMITED
kuendesha biashara ya MEDICAL LABORATORY EQUIPMENT
katika Wilaya/Kanda* ya ILALO Mtaa VINGUINGUTI
4. Ni ya Shina/Tawi* INDUSTRIAL AREA
Ada Sh. 200,000/= Nambari ya Stakabadhi 506031
ya tarehe 06/08/2021
5. Mpya inaendeleza* mada wa Leseni Na. 3838608
ya tarehe 08/08/2021

(ii) Mada wa leseni hii utabwa (30 Juni 20) 28/07/2022

Tarehe
GP-DSM

12/08/2022
0653550017



Shenubi
Mines
Sachu wa Mshauri wa Attoaji Leseni



THE UNITED REPUBLIC OF TANZANIA

BUSINESS LICENCE

B.L.No: 20000020643

The Business Licensing Act No. 25 of 1972 (R.E. 2002)

1. Issuing office : **BUSINESS REGISTRATIONS AND LICENSING AGENCY**
2. Tax Identification Number: **100-107-724**
3. Licence issued to: **KAS MEDICS LIMITED** for the Business of : **Import And Sale Of Pharmaceuticals And Medical Devices**
4. Business Location
Region: **Dar Es Salaam**
District: **Ilala Municipal Council**
Ward: **Vingunguti**
Street: **VINGUNGUTI INDUSTRIAL AREA**
5. Principal/Branch: **Principal**
6. Amount of fee paid: **TZS 400000** Receipt No: **1858208** on: **09/08/2021**
7. Renew of Licence No: **20000008388** Dated: **04/08/2020**
8. Date of Issue: **12/08/2021** Expiring date: **12/08/2022**



This digital copy does not require a signature authority

NOTE - This Business Licence must be kept in a conspicuous position at the principal place of business. Any change in the particulars originally registered must be notified to the Licence Issuer.

TANZANIA



Certificate of Incorporation

No. 18097

I HEREBY CERTIFY THAT

K A S M E D I C S Limited

is this day incorporated under the Companies Ordinance (Cap. 212) and that the Company is Limited.

Given under my hand at Dar es Salaam

this 5th day of JUNE

One thousand nine hundred and NINETY

[Signature]

[Signature]

Senior Asst: Registrar of Companies

DEL MEDICAL

Del Medical Inc.
241 Covington Drive
Bloomington, Illinois 60108
Toll Free: 800 800 6006
Phone: 847 288 7000
Fax: 847 288 7011

MANUFACTURER'S AUTHORIZATION LETTER

03rd December, 2021

To:
Executive Director,
Ocean Road Cancer Institute,
P. O. Box 3592
Dar Es Salaam.

WHEREAS Del Medical, Inc. who are established and reputable manufacturers of general x-ray systems having factories at 241 Covington Drive, Bloomington, Illinois 60108, USA do hereby authorize **KAS MEDICS LTD** of Vingunguti Industrial Area, Plot No. 11, along Nyerere Road, to submit a Tender, and subsequently negotiate and sign the Contract with you against **TENDER: PA-010/2021-2022/G/37** with Title **Supply, installation and commissioning of Digital X Ray at Mtwara Zonal and Morogoro RHH** for the goods manufactured by us. We hereby extend our full guarantee and warranty as per Clause 28 of the General Conditions of Contract for the goods offered for supply by the above firm against this Invitation for Tenders.



Jose Garces
Director - International Sales



[Signature for and on behalf of Manufacturer]

Note: This letter of authority should be on the letterhead of the Manufacturer and should be signed by a person competent and having the power of attorney to bind the Manufacturer. It should be included by the Bidder in its Tender.

